

Northeast Tri County Health District

*Standards and Guidance for Performance, Application, Design, and
Operation & Maintenance*

Pressure Distribution Systems

Based on the Washington State Department of Health (DOH) “Recommended Standards and Guidance for Performance, Application, Design, and Operation & Maintenance for Pressure Distribution Systems, July 2009.”

Effective Date: March 1, 2010

Table of Contents

Introduction.....	4
1. Performance Standards.....	7
1.1. Intent	7
1.2. Measure of Performance	7
2. Application Standards.....	9
2.1. Listing	9
2.2. Permitting.....	9
2.3. Pretreatment	9
2.4. Pump Chamber.....	11
2.5. Pumps, Fittings and Controls.....	12
2.6. Piping Materials.....	17
2.7. Manifold.....	17
2.8. Laterals.....	19
2.9. Minimum Design Submittal.....	22
2.10. Construction Record Information	23
2.11. User’s Manual.....	23
3. Operation and Maintenance	24
3.1. Evaluate Drainfield.....	24
3.2. Evaluate Laterals.....	24
3.3. Measure Pump Run Time per Cycle and Drawdown	25
3.4. Test Alarms.....	25
3.5. Evaluate Septic Tank and Pump Chamber.....	25
3.6. Findings and Repairs	25
Figures.....	26
Appendix A – Useful Tables for Pressure Distribution.....	37
Appendix B – Volume of Pipe	51
Appendix C - Advantages / Disadvantages of Dosing Systems.....	52
Appendix D - Advantages / Disadvantages of Siphon Dosed Systems	54
Appendix E - References	55

How this document is organized:

Standards Section	Explanation
Performance	How this technology is expected to perform (treatment level and function)
Application	How this technology is to be applied. This section includes conditions that must be met prior to proceeding with design. Topics in this section describe the “approved” status of the technology, component listing requirements, permitting, installation, testing and inspection requirements, etc.
Design	How this technology is to be designed and constructed (includes minimum standards that must be met to obtain a permit).
Operation and Maintenance	How this technology is to be operated and maintained (includes responsibilities of various parties, recommended maintenance tasks and frequency, assurance measures, etc)
Appendices	Design examples, figures and tables, specific applications, and design and installation issues.

Introduction

Pressure distribution applies effluent uniformly over the entire absorption area such that each square foot of bottom area receives approximately the same amount per dose at a rate less than the saturated hydraulic conductivity of the soil. This process promotes soil treatment performance by maintaining vertical unsaturated flow and also reduces the degree of clogging in finer textured soils. Pressure distribution closely approaches uniform distribution. (See guidance section below)

A pressure distribution system consists of a pretreatment component to separate the major solid materials from the liquid, a screening device to protect the pump and distribution lateral orifices from solids, and a means to deliver specified doses of effluent, under pressure, to the distribution system (Converse, 1974; Converse, et al., 1975; Otis, et al., 1978). The distribution system consists of small 1 to 2 inch diameter laterals with small discharge orifices. A pressure head is created within the laterals, usually by means of a pump or siphon.

Pressure distribution is applicable to any system which uses soil as a treatment medium and may improve long term performance of those systems. It is required by WAC 246-272A for certain site and soil conditions, and for high daily design flows. Pressure distribution is also a required component for mounds, sand filters and sand lined trenches and beds.

Research evidence indicates that wastewater traveling vertically through 2-4 feet of suitable, unsaturated soil provides adequate treatment of wastewater. Research also indicates that the method of distribution of septic tank effluent within the soil absorption field can affect the system's treatment performance.

A frequently used, and the simplest method for distributing effluent is gravity flow. Gravity flow allows wastewater to flow by gravity through large diameter pipes into the subsurface soil absorption system. Distribution is usually localized in a few areas within the field, which results in overloading of the infiltrative surface in those areas until a mature biomat develops. This overloading can lead to groundwater contamination in coarse granular soils due to insufficient treatment, or more rapid clogging in finer textured soils.

A second method of distribution, dosing, can overcome some of these problems. It is dealt with in a separate publication entitled, Dosing Gravity Drainfield Systems. Because effluent is distributed over a larger portion of the absorption area and the period between doses is maximized, the degree of soil clogging is reduced. However, localized overloading may still occur.

A third method is pressure distribution, which comes closest in achieving uniform distribution. Pressure distribution is usually used in locations where it is either desirable or required to:

- 1) achieve uniform application of wastewater throughout the drainfield area;*
- 2) treat and dispose of effluent higher in the soil profile;*
- 3) avoid potential contamination of ground water beneath excessively permeable soils;*
- 4) improve the treatment performance and extend the life expectancy of a drainfield or other component;*
- 5) reduce the potential for breakout or seepage on slopes;*
- 6) distribute effluent to all sand filters, mounds, all Type 1 soils, and all other soils with less than 24 inches of vertical separation.*

Pressure distribution is also appropriate for sites in aquifer sensitive areas and for larger drainfield systems. Finally, in certain conditions where pumping is necessary due to elevation problems, pressure distribution can be incorporated with only a little additional effort.

System Components / Process Summary

Pressure distribution systems require the following basic components: septic tank (or other pretreatment to the same quality as domestic septic tank effluent), pump or siphon chamber or equivalent, transport line, manifold, laterals, and drainfield.

Figure 1 illustrates the major components of a typical pressure distribution system that are described below:

<u>Component</u>	<u>Primary Function</u>
<i>Septic tank (or other pre-treatment device)</i>	<i>Solids separation and storage</i>
<i>Screen</i>	<i>Protect pump and distribution network orifices from solids</i>
<i>Pump chamber (surge tank)</i>	<i>Transport a specific volume of effluent from the surge tank pump chamber to the distribution network. Accumulate effluent between pump cycles and during malfunction.</i>
<i>Transport line</i>	<i>Pipeline that connects the pump to the Manifold.</i>
<i>Manifold</i>	<i>Piping network connecting the transport line to the various laterals.</i>
<i>Control Panel</i>	<i>NEMA-rated box containing all the controls for the pumping system, dose cycle counter, pump run time meter, and alarm controls.</i>
<i>Laterals</i>	<i>Small diameter pipes with orifices which distribute effluent within a trench or bed.</i>
<i>Drainfield</i>	<i>Allows the septic tank effluent to pass into the native soil or other receiving media where various biological and physical processes provide additional treatment.</i>

1. Performance Standards

1.1. Intent

The intent of pressure distribution is uniform distribution of effluent throughout the receiving component.

1.2. Measure of Performance

The variation in orifice discharge rates within any one lateral must not be more than 10%,

The variation in orifice discharge rates over the entire distribution system must not be more than 15%,

*The squirt height difference must not exceed 21% (10% flow difference) between orifices on any one lateral. The squirt height difference over the entire system must not exceed 32% (15% flow difference). **Remember to use a new drill bit during construction.** The following table gives the actual distances.*

<u>Nominal Residual Squirt Height</u>	<u>Maximum Flow Difference Allowed (Inches)</u>	
	<u>10% Flow Difference</u>	<u>15% Flow Difference</u>
2 Feet	5 Inches	7.5 Inches
5 Feet	12.5 Inches	19 Inches

- 1.2.1. A minimum residual pressure of 0.87 psi (2 feet of head) is required for systems with 3/16 inch diameter orifices and larger, and 2.18 psi (5 feet of head) is required for systems with orifices smaller than 3/16 inch.

Generally, the testing should verify that distribution is uniform with the required minimum residual pressure, that the system is dosed at the proper volume and frequency, and that the alarms are functioning properly. Suggested methods are provided below. If problems are encountered during testing, the installer should notify the designer or engineer. Wiring problems should be referred to the electrician. Described below are the steps for conducting a pressure test.

- *Measure squirt height.*

Minimum squirt height for orifice size:

3/16" orifice size = 2' or 24" squirt height

1/8" orifice size = 5' or 60" squirt height

5/32" orifice size = 5' or 60" squirt height

- *Check uniformity of squirt height.*

- ❑ *An alternate method to the squirt height is to attach a clear PVC stand pipe to the end of the lateral. The true residual head is measured from the top of the lateral pipe to the top of the water column.*
- ❑ *Check float placement. High water alarm, “on” level, “off” level, and “redundant off” alarm must activate or deactivate at the elevation called out on the plan. It is recommended that, for simplicity and accuracy, these adjustments be made with the float free out of the water.*
- ❑ *Ensure that the pump delivers the correct dose to the drainfield.*
- ❑ *Demand dose systems: Verify that “dry” float settings (completed above) send the correct dose to the drainfield when floats are in water. This may require minor adjustments of float placement.**
- ❑ *Timed dose systems:*
 - (1) *Determine the time required to send a full dose to the drainfield. This can be done by running the system in manual. Be sure there is plenty of water in the pump chamber. Timer run times provided by designers or engineers must be field tested.*
 - (2) *Using the time obtained above, verify that when the system runs automatically it runs the time required to send the proper dose to the drainfield. This is important because timers are difficult to set, i.e., setting a timer to 2.2 minutes may not ensure a run time of 2.2 minutes. Two steps to speed this process are to start testing with the pump chamber mostly full and to set “off” time temporarily to minutes or seconds.**
 - (3) *Verify that the timer off time is the same as that specified in the plan or will dose the system the correct number of times a day. Check this number in minutes and note the off time. One can verify activation levels by use of lights on timer. For instance, if the drainfield is to receive 4 doses per day, the off time should be approximately 6 hours.*
 - (4) *Verify that high water alarm does not turn the pump on. If high water alarm turns the pump on, the system will not be approved.*

Timed dose systems only: Verify that the system will dose the correct number of times per day and that no float in the system turns the pump on independent of the timer. A system with a timer override float will not be approved.

If problems are discovered during the functional testing, first contact the designer or engineer. If the wiring needs adjustment, the electrician should be contacted.

In preparation for Health District final inspection, fill the pump chamber.

An additional test for equal distribution, which takes into consideration draindown after the pressure cycle, is described here. However, it is somewhat tedious. For systems with laterals

having more than 18 inches difference in elevation, the volume of liquid from an orifice (same size as the others in the laterals) placed in a plug or cap in the end of each lateral can be collected from a complete cycle and measured. The variation between the largest volume and the least volume collected must not be more than 15%. Use of manifold designs shown in Figures 6A and 6B will eliminate significant drainback.

** Determination of float activation level in water may take several tries. For both system types, note pump run time that delivers proper dose. Record the results.*

2. Application Standards

2.1. Listing

Pressure distribution is a public domain distribution technology, but it does not appear on DOH's List of Registered On-site Treatment and Distribution Products. It may be permitted by the health officer as a public domain pressure distribution system (WAC 246-272A-0010) as long as there is DOH's RS&G for this technology.

2.2. Permitting

Installation permits, and if required, operational permits must be obtained from the health officer prior to installation and use.

2.3. Pretreatment

2.3.1. A pressure distribution system must be preceded by a properly sized two-compartment septic tank with effluent baffle screen (see 2.3.3). Exception, see 2.4.2.

2.3.2. Septic Tank - The septic tank must be designed in compliance with Washington State On-Site Sewage System Regulations (WAC 246-272A-0232) and with Chapter 246-272C On-site Sewage Tanks. All septic tanks must:

2.3.2.1. be watertight. The health officer may require leak testing.

2.3.2.2. include screening of the effluent, unless the screening is around the pump.

2.3.3. Outlet Baffle Screen / Filter - An outlet baffle screen or filter must meet the following performance criteria:

2.3.3.1. protect the pressure distribution drainfield discharge orifices from plugging by particles larger than the orifices.

2.3.3.2. protect the effluent pump from damage due to particles which exceed the pump's capacity to pass (may be an issue with some types of pumps).

- 2.3.3.3. perform these functions without loss of performance between routine service events.
- 2.3.3.4. perform these functions with routine service no more frequent than that required for other system components or the system as a whole.
- 2.3.3.5. is constructed of durable, non-corroding materials.
- 2.3.3.6. draws liquid from the “clear zone” of the septic tank.
- 2.3.3.7. be designed, constructed and installed for easy and thorough cleaning.

Outlet Baffle Screen / Filter -- Effluent flowing through a screen at the outlet of the septic tank is at very low head and therefore particles cannot be forced through the openings. In addition, servicing the screen does not involve pump, control floats, wiring and discharge pipes. Below are listed some specific criteria for baffle screens that meet the standards.

Maximum mesh opening of 1/8 inch (protects discharge orifices of 3/16 inches or larger, and pumps with the capacity to pass up to a 1/8 inch sphere. For orifices smaller than 3/16 inches diameter, the screen should have a mesh size of 1/16 inch smaller than the orifice it is designed to protect.)

Non-corrosive material (durability leads to improved product life-span and performance).

Provide an open area flow capacity at least equal to the flow capacity provided by a 4 inch diameter PVC pipe. The minimum area will very likely require a high frequency of cleaning and therefore not meet the standard of performance between service intervals. In standard practice a much larger flow area is used. The larger flow areas will result in longer intervals between services for the same hydraulic and organic strength loadings.

The screen must be securely fastened to prevent dislodging or misalignment (this relates to long-term performance and servicing).

Be easily removable and/or designed, constructed and installed for easy and thorough cleaning (this relates to long-term performance and servicing).

Draw liquid from the “clear zone” of the septic tank, the zone between 40% down from the top of the liquid and 40% up from the bottom of the tank (this relates to performance and service interval, as well as general septic tank performance).

Be capped, covered or otherwise constructed to prevent scum or other floatable solids from discharging from the tank by bypassing the screen or filter (this relates to product performance).

Other specifications may be used to meet the outlet baffle screen / filter performance.

2.4. Pump Chamber

2.4.1. Pump Chamber Requirements - All pump chambers must be structurally sound and conform to Washington State On-Site Sewage System Regulations (WAC 246-272A) and Chapter 246-272C On-site Sewage System Tanks. All tanks must:

2.4.1.1. be water tight. Leak testing may be required.

2.4.1.2. all pump chambers must be equipped with a twenty-three (23) inch minimum diameter, water tight riser with a secured lid that extends to the ground surface. Lids must be equipped with an airtight gasket to eliminate nuisance odors and be secured from accidental or intention removal by unauthorized persons, especially children.

2.4.1.3. the internal volume of the pump chamber must be sufficient to provide the daily design flow volume, dead space below the pump inlet for sludge accumulation, and sufficient depth to provide full time pump submergence, when required. An additional emergency storage volume of at least 75% of the daily design flow is also required (may include volume to flood capacity in both the pump tank and the septic tank).

Pump Chamber Volume - For most applications, an 18 inch minimum space for sludge accumulation in the pump chamber is prudent. Pump chambers receiving septic tank effluent will accumulate sludge and scum, and in some new systems it will form quite rapidly. The sludge level will never be above the intake of the pump. Emergency storage is required for periods of power outages or equipment malfunctions.

For systems where continuous operation and maintenance are provided by a management entity acceptable to the health officer, a reduction in the volume required for reserve storage may be considered.

Reductions in pump chamber volume may also be considered when "Duplex" or redundant pumps are used.

2.4.1.4. include a screen if one is not provided at the outlet of the septic tank. (See 2.3.3 for performance criteria of the screen.) The health officer may allow this option only if O&M is assured through contract with third party entity.

Screening at the septic tank outlet may result in a higher quality effluent than screening around the pump, as the flow rate through a septic tank baffle screen is much lower than through a screen around the pump. However, large pump chambers can continue to accumulate

screenable solids, as it is still a biologically active fluid. Therefore, it should be assumed that septic tank effluent, once screened, can still produce sludge and scum in the pump chamber. A pump screen designed to fulfill the performance requirements and to prevent collapsing between service intervals may be a wise choice either by itself or in conjunction with a septic tank effluent filter. However, some pumpers insist that screens in pump chambers are a bad idea and cause many maintenance problems.

2.5. Pumps, Fittings and Controls

2.5.1. Pumps must be selected to pump effluent and be capable of meeting the minimum hydraulic flow and head requirements of the proposed on-site system. Additional requirements that pumps and pump installations must meet are:

2.5.1.1. Pumps

2.5.1.1.1. All pumps must be installed so that they can be easily removed and/or replaced from the ground surface. (Under no circumstances shall pump replacement and/or repair require service personnel to enter the pump tank).

2.5.1.1.2. All pumps must be fitted with unions, valves and electrical connections necessary for easy pump removal and repair. All pumps must be protected by approved outlet baffle screens in the chamber preceding the pump chamber or by pump screens, as described in previous sections.

In addition, pumps and controls should have gas-tight junction boxes or splices and have electrical disconnects (as per National Electric Code) appropriate for the installation. The boxes should be placed so that they do not interfere with the servicing of other components.

2.5.1.1.3. Pumps and electrical hook-ups must conform to all state and local electrical codes.

2.5.1.1.4. If any portion of the pump fittings or transport line is at a higher elevation than the drainfield, the system must be equipped with an air vacuum release valve or other suitable device to avoid siphoning.

If a check valve is used in the system, a vent hole should be installed upstream from the check valve so the pump volute (impeller chamber) is kept filled with effluent. Some pumps may cavitate if the impeller is not kept submerged. Under most circumstances this hole will be needed only when the chamber is first filled with liquid or after it has been cleaned.

2.5.1.2. Pump Controls

- 2.5.1.2.1. Timed dosing is recommended whenever pressure distribution is used. NETCHD Regulation 01-2007 requires timed dosing in the soil dispersal component for all sites where technologies meeting Treatment Levels A or B are mandated, soil dispersal components having daily design flows between 1000 and 3500 gallons of sewage per day, and in the soil dispersal component following all repairs using the allowances of Table VI in Section 24 NETCHD Regulation 01-2007. Technologies, such as sand filters, recirculating gravel filters, sand lined trenches, mounds, and other treatment components also require timed dosing in order to assure those technologies meet treatment requirements or expectations. For systems requiring time-dosed pressure distribution, accessible controls and warning devices are required, and must:
- 2.5.1.2.1.1. meet the functional requirements for pressure distribution,
 - 2.5.1.2.1.2. deliver prescribed dose sizes uniformly to the orifices in the distribution network,
 - 2.5.1.2.1.3. deliver the effluent to the distribution network in evenly spaced doses over a 24 hour period,
 - 2.5.1.2.1.4. provide prescribed resting periods between doses,
 - 2.5.1.2.1.5. assures no more than the design volume for each 24 hour period is delivered to the receiving component,
 - 2.5.1.2.1.6. record and store the pump run time and number of dose cycles,
 - 2.5.1.2.1.7. have controls and components listed by Underwriter's Laboratory or equivalent, and
 - 2.5.1.2.1.8. alarm circuit independent of the pump circuit.

Timed dosing is not required for pressure distribution soil dispersal components following treatment components that are timed dosed. The flow is already time-dosed to the treatment component, and therefore the pump chamber out of the treatment component may be demand-dosed. To detect extraneous flows, an elapsed time meter can be used to monitor the integrity of the liner of a packed bed filter, such a sand filter, by comparing the volume of liquid pumped from the sand filter with the volume pumped into it.

Timed dosing is strongly recommended on all pressure distribution systems. This type of system enhances performance, reliability, and protection from abuse. The requirements in WAC 246-272A and the recommendations in this document are based on the need to control the size of doses to the coarser and single grained soils and treatment media. Timed dosing also prevents hydraulic overload of the receiving component. Usual sources of hydraulic overload are excessive water use in the facility or groundwater infiltration into the septic tank or pump chamber.

Timed dosing means that both the length of each dose (produces gallons per dose) and the interval between doses (which determines the number of doses per day) is controlled by a timing device whenever a dose volume is in the pump chamber. The number of pump cycles should be adjustable and in sufficient number to meet the design needs of the system.

As the number of dose cycles increases, the amount of effluent delivered per dose must decrease (in order to prevent more than daily design dose from being delivered to the drainfield). Delivering more than 6 or 8 doses per 24 hours will require one or more of the following features to be designed into the system:

- *orifices at 12:00 o'clock to keep the piping network full or mostly full of effluent between doses (to reduce the volume per dose)*
- *transport, manifold and lateral pipe diameters are reduced (to reduce the volume per dose)*
- *orifice size is reduced (to help reduce the volume per dose)*
- *fluid velocity in pipes is increased (to help scour the pipe and as a consequence of the reduced pipe size)*
- *residual hydraulic head at the orifices is increased (to help clear the smaller orifices)*
- *check valves are placed into the system to prevent flowback (to reduce the volume per dose)*
- *a performance test of the check valves, as many do not perform as intended.*

2.5.1.2.2. When the treatment component is timed dosed prior to a soil dispersal component, the soil dispersal component does not need separate timed dosing. In this case, only a demand dosing system with a dose cycle counter and hour meter (or a water meter on the water supply or sewage stream) is required for the soil dispersal component.

2.5.1.2.3. Demand controlled pressure distribution systems must include an electrical control system that:

2.5.1.2.3.1. has the alarm circuit independent of the pump circuit.

2.5.1.2.3.2. will meet the functional and reliability requirements for pressure distribution.

2.5.1.2.3.3. has controls and components that are listed by UL or equivalent.

2.5.1.2.3.4. is secure from tampering and resistant to weather (minimum of NEMA 4).

2.5.1.2.3.5. located outside, within line of sight of the pump chamber.

2.5.1.2.4. All control panels must have cycle counters and elapsed time meters for all pumps. Alternatively, a water meter on either the water supply or sewage streams will satisfy this requirement.

2.5.1.2.5. All control panels must be equipped with both audible and visual high liquid level alarms and the alarms must be placed in a conspicuous location.

2.5.1.2.6. Float switches must be mounted independent of the pump and transport line so that they can be easily replaced and/or adjusted without removing the pump.

The minimum requirements for timed pump cycle controls are a timer actuator float for the pump and a high liquid level alarm. In addition, a low liquid level off float is highly recommended. [See next section, Floats, for a discussion.]

2.5.1.2.7. Electrical control and other electrical components must be approved by Underwriters Laboratories (UL) or equivalent.

2.5.1.2.8. Other standards that engineers, designers and installers need to be aware of and comply with are electrical standards for pump and control systems established by Washington State Department of Labor and Industries.

A control box or panel installed on a treated 4" X 4" post is acceptable practice and does not produce irritating resonations for the building occupants as occurs when the control panel is mounted on buildings.

2.5.1.2.9. Minimum Dose Frequency - The minimum dosing frequency must be according to the following:

Soil Type 1 and 2	4 times per day
Soil Type 3	4 times per day
Soil Types 4-6	1 to 2 times per day

Dose Frequency - Although this standard lists the minimum frequency for various soil types, more frequent doses than the minimum recommendation may be desirable in some designs. Dosing of drainfields provides intermittent aeration to the infiltrative surface. With this method, periods of loading are followed by periods of resting, with cycle intervals ranging from hours, to

a day or more. The resting phase should be sufficiently long to allow the system to drain and expose the infiltrative surface to air, which encourages degradation of the clogging materials by aerobic bacteria. In sands, however, the rapid infiltration rates can lead to bacterial and viral contamination of shallow ground water, especially when first put into use. Therefore, systems constructed in these soils should be dosed with small volumes of wastewater four or more times a day to prevent saturated conditions from occurring and hence, inadequate treatment. In finer textured soils, saturated flow is much less likely, so frequent doses do not add to the performance. Large, less frequent doses are more suitable in these soils to provide longer aeration times between doses (EPA, et al).

2.5.2. Floats (or other types of liquid level sensors)

2.5.2.1. For pump chambers serving single family residences, the necessary floats or liquid level sensors are to actuate and turn off the pump control system, and a high water alarm float. “Redundant off” controls are optional, but highly recommended, and may be required by the health officer.

2.5.2.2. Commercial and multi-family applications are required to meet Washington State Department of Labor and Industries requirements for Class I, Division I locations. These locations include redundant off and special ratings on installed motors and equipment.

2.5.3. Siphons - Siphons may be used for charging a pressure distribution system. However, they are flow-dependent and cannot provide evenly spaced doses, nor limit the daily volume (See Appendix D). Therefore, siphons cannot be used where standard 2.5.1.2 is required unless specific design elements cause the siphon to produce the performance of 2.5.1.2. Where siphons are used the following requirements apply:

2.5.3.1. The area to be dosed must be downhill from the siphon chamber and according to manufacturer’s instructions for minimum elevation differential.

2.5.3.2. The effluent must be screened before entering the siphon chamber.

2.5.3.3. The siphon must be installed to allow access for maintenance and cleaning.

2.5.3.4. The dose counter(s) must be incorporated into the design and installation.

2.5.3.5. Siphons can only be used where timed dosing is not required, or where some system or arrangement delivers effluent to the siphon chamber evenly over a 24 hour period and no more than the maximum design flow for the system.

These criteria can be met by the use of a small electric pump, which delivers effluent to the

siphon chamber evenly over a 24-hour period. This pump is sized to deliver no more than the daily design flow to the siphon chamber in a 24 hour period. The siphon then doses a sand filter, mound or sand-lined drainfield.

- 2.5.3.6. Siphons may only be used where they will be monitored and managed to the satisfaction of the health officer.

Other important considerations:

- *Proper siphon size must be selected, as they are available in many sizes.*
- *Air leaks in the siphon or fittings will prevent the siphon from functioning.*
- *If the siphon chamber fills too rapidly, the bell and siphon will not receive a full dose of air and will enter a trickling mode.*
- *Adjustment to the "trip" level of the liquid in the siphon chamber is limited; dose volume is better handled by careful sizing of the siphon chamber.*
- *Blockage of the snifter tube, even momentarily, at the end of the discharge cycle, will cause the siphon to enter a trickling mode.*
- *Transport pipe must be vented just outside the siphon chamber and other venting must be placed in the system as needed.*
- *It is advisable not to bury the transport pipe until the system is tested and proper operation is verified; additional venting may be needed for unanticipated air locks (see Figures 9 and 10).*

2.6. Piping Materials

The pipe materials must meet the following minimum specifications:

2.6.1. At a minimum, the material must meet ASTM D2241 Class 160 or equivalent.

2.6.2. For schedule 40 and schedule 80 PVC, use ASTM D1785.

2.7. Manifold

(See Appendix A-4)

The primary function of the manifold is to deliver equal flow to all lateral orifices while minimizing system friction losses. While manifold patterns may take many forms, the most common are the center and the end manifolds. End manifolds suffice for short laterals but center manifolds allow for use of smaller lateral pipe sizes.

Manifold / Lateral Connection:

The laterals can be connected to the manifold in several ways. The manifold to lateral connection must be appropriate for the site conditions and the specific use. Several types are described below:

- *A header manifold is positioned at an elevation below the laterals (Figure 3A), with*

check valves, flow control valves and feeder lines to each lateral. This configuration will maintain the manifold, feeder lines and laterals full between doses, will not allow drain back, and can be adjusted at one location to equalize residual head in all laterals. This arrangement can deliver small volumes per dose, allowing many doses per day, if desired. Caution should be taken to minimize the potential for effluent freezing in the laterals and manifold.

- *A header manifold is placed at an elevation above the laterals (Figure 3B) without check valves, with flow control valves and feeder lines to each lateral. The measured flows from an orifice in each lateral are nearly equal without the use of check valves and without maintaining the system full between doses.*
- *Tee-to-Tee with manifold below (See Figure 4) - When freezing and sloping site conditions are not a concern, this method of construction can be used to allow a very rapid pressurization of the system, especially if the transport line remains full between doses. When check valves are used in the manifold just downstream of each lateral, the manifold (and laterals too, when orifices are in the 12 o'clock position) stays full of effluent between doses. With this style, (1) there is no drainback from the upper laterals and manifold into the lower lateral, (2) the system is completely charged within just a second or two after the pump is turned on, and (3) the system can be dosed with very small volumes per dose.*

[Note caution about check valves in section 2.7.1. of this section.]

- *Cross construction (See Figure 5) - If the lateral orifices are drilled in the 6 o'clock position, this design will allow the laterals and a portion of the manifold to drain between doses, assuming the transport line remains full between doses.*
- *Tee-to-Tee with the manifold above - If the lateral orifices are drilled in the 6 o'clock position, the entire distribution network will drain after each dose. This may be desirable on a sloping site (where check valves are not installed in the manifold), to prevent upper laterals from draining back through the manifold to the lowermost laterals, thereby overloading them. If the orifices are drilled in the 12 o'clock position, the laterals will remain full between doses. This may be desirable when the objective is to pressurize the distribution network quickly without the use of check valves. Caution should be taken to minimize the potential for effluent freezing in the laterals.*

Sloping Sites: *Manifold designs for sloping sites are particularly critical. Laterals at different elevations will have different residual pressures, with the lowest lateral having the highest residual. In addition, if the manifold is not designed correctly the lowest lateral will receive pressure before the top lateral and system backflow will continue to the lower laterals after the pumping cycle has ended. In this instance, the lowest trench will receive more flow than the others, with the potential for overload. While there may be several solutions to these problems, Figures 3A & 3B illustrate two methods for resolving them. The check valves and flow control valves shown in Figure 6A and 6B are assumed to be an integral part of the manifold.*

2.7.1. Check Valves

- 2.7.1.1. When check valves are used, they must be installed so that they can be removed for servicing or replacement. This means that unions or some other fitting need to be included in the installation of check valves.

- 2.7.1.2. The location of check valves must be well documented and marked.
Preferably they are located in a structure that is accessible from the surface.

Check valves occasionally require maintenance, and therefore should be installed so that they can be removed for servicing or replacement. Unions placed at the check valve are a common means to allow servicing of the check valves while avoiding destruction or severe excavation of the manifold. Some brass check valves can be disassembled without removing them from the line.

2.8. Laterals

(See Appendix A-1, A-2, A-3)

The laterals in a pressure distribution system are perhaps the most important design aspect. All design considerations to this point are essentially to serve the delivery of equal flows to each square foot of drainfield bottom area.

Orifice Design:

The actual flow rate from each orifice is best represented by the equation:

$$Q_o = 11.79 d^2 h^{0.5}$$

where:

- Q_o is the orifice flow in gallons per minute
 d is the orifice diameter in inches
 h is the discharge head in feet (also called residual head)
(see Appendix A-2 for a derivation of this equation)

There are other factors complicating accurate calculation of the orifice flow rate such as accurate drilling of holes, class of pipe, size of pipe, and slight variations in the friction coefficients used for fittings. Proper technique and practice in drilling holes includes use of proper drill size and a sharp bit. Accurate holes also may require jigs or other drill stabilizing tools to prevent wobble and to drill the hole perpendicular to the pipe. Proper layout and control will ensure that the design number of orifices are actually placed in each lateral.

The above formula for calculating orifice discharge rates is recommended. However, the choice of coefficient to use in a design can vary from 11.79 to 16, depending on the experience of the designer in being able to predict accurately and control for the friction losses and other variables of construction and manufacture. For many designers, experience has shown that use of a slightly higher coefficient in the equation more accurately predicts the actual flow. For whichever coefficient is selected, it is critically important that the same coefficient be used throughout the design. Other ways to handle the inaccuracies are to add 10% to the total flow after the calculations, or to design to more than minimum residual head. All of these are acceptable.

2.8.1. Residual Pressure Requirements - For systems with orifice diameters of 3/16 inch or larger, the minimum residual head at the orifice is 2 feet (.87 psi). For systems with orifices less than 3/16 inch diameter, the minimum residual head is 5 feet (2.18 psi).

2.8.2. Orifice Size and Orientation

2.8.2.1. Orifices must be no smaller than 1/8 inches in diameter.

2.8.2.2. When using gravelless chambers with pressure distribution, the orifices must be oriented in the 12 o'clock position. If one or two orifices are placed in the 6 o'clock position to facilitate draining after each pump cycle (to prevent freezing in areas of the state where that may occur or to prevent build-up of microbial growth inside the laterals), they must have some mechanism to break the flow (an orifice shield that drains, a pad of gravel, etc.).

See sections on orifice size, orientation and shields, and Figure 7.

2.8.3. Orifice Spacing

To prevent excessive variations in discharge rates and possible subsequent localized hydraulic overload, the maximum acceptable flow deviations stated in the Performance Testing section (Section 1.2.) of this document must be heeded.

2.8.3.1. Sand filters (including sand lined trenches), mounds and pressure distribution in soil types 1, and 2 and in medium sands, must have a minimum of one orifice per 6 ft² of infiltrative surface area, evenly distributed.

2.8.3.2. In other soil types, there must be a minimum of one orifice every six feet on center along the lateral.

While these are minimum requirements, orifices spaced at closer intervals may be prudent. Closer orifice spacing should be considered when small doses are specified and where the infiltrative surface is in highly structured soils or has large macropores.

2.8.3.3. The maximum spacing between the outside laterals and the edge of the trench or bed must be 1/2 of the selected orifice spacing, ±0.5 feet.

2.8.4. Orifice Shields

Orifice shields may be the half pipe design, the local cap type, or another design which accomplishes the same end result. See Figure 7.

- 2.8.4.1. When orifices are oriented in the 12 o'clock position, orifice shields or gravelless chambers must be provided.
- 2.8.4.2. The shields must be strong enough to withstand the weight of the backfill and large enough to protect the orifice from being plugged by pieces of gravel.
- 2.8.5. Cleanouts and Monitoring Ports
 - 2.8.5.1. All pressure distribution laterals must be equipped with cleanouts and monitoring ports at the distal ends (see Figures 8A and 8B). These cleanouts and monitoring ports must:
 - 2.8.5.1.1. have threaded removable caps or plugs on the ends of the laterals to allow for cleaning the laterals and for monitoring the lateral pressure,
 - 2.8.5.1.2. be large enough to allow access to caps or plugs with hands, tools, etc.
 - 2.8.5.1.3. be accessible from the ground surface,
 - 2.8.5.1.4. be open and slotted at the bottom, and
 - 2.8.5.1.5. be void of gravel to the infiltrative surface to allow visual monitoring of standing water in the trench or bed.
 - 2.8.5.2. All designs must show them in detail and explain how they accomplish the respective tasks.

The functions of monitoring and cleanout can be separated and also be accomplished in other ways.

2.8.6. Trenches

- 2.8.6.1. In a pressure drainfield, as in any drainfield, the bottom of the trench must be level, ± 0.5 inches.
- 2.8.6.2. The bottom and sides of the trench must not be smeared.
- 2.8.6.3. In gravel-filled trenches and beds, an acceptable geotextile must be used on top of the gravel before backfilling.
 - 2.8.6.3.1. The geotextile barrier must be a fabric that is spun-bound (non-woven), free of any chemical treatment or coated which reduces permeability, inert to chemicals commonly found in soil, free of petroleum products, and have a fabric weight of three to four ounces per square yard, or an apparent opening size (AOS) of 0.212 to 0.300 millimeters.
- 2.8.6.4. On sloping sites, the trenches and laterals must run parallel to the natural ground contours.

2.9. Minimum Design Submittal

A completed design must include the following as a minimum:

- 2.9.1. meeting all requirements of Section 11 of NETCHD Regulation 01-2007,
- 2.9.2. daily design flow,
- 2.9.3. septic tank size, location and outlet invert elevation,
- 2.9.4. pump pickup elevation and location, or siphon invert elevation and location,
- 2.9.5. size of pump or siphon chamber,
- 2.9.6. transport line length, location, highest elevation, and diameter,
- 2.9.7. all valves or other such components in the system,
- 2.9.8. manifold diameter, location, length, and orientation,
- 2.9.9. lateral diameter, location, length, orientation, and elevations,
- 2.9.10. orifice diameter, spacing, and orientation,
- 2.9.11. dose volume, pumping rate (gpm), dose frequency, and design residual pressure,

- 2.9.12. location and detail of access ports on the laterals,
- 2.9.13. detail of pump controls, floats, and the position of the floats,
- 2.9.14. an electrical wiring diagram specific to the project,
- 2.9.15. system parameters and calculations used by the designer to arrive at the component sizing and flow distribution shown in the design, and
- 2.9.16. a user's manual for the pressure distribution system must be developed and provided to the homeowner and the NETCHD. This document is the responsibility of the designer and is to be included with the design submittal.
- 2.9.17. the following statement above the designer's, engineer's, or homeowner's signature: " I certify that this design meets all regulations and rules of the Washington State Department of Health and the Northeast Tri County Health District."

2.10. Construction Record Information

A completed construction record submission must be completed and contain, at a minimum, the following items:

- 2.10.1. all the items contained in the design submittal listed above, as installed, identifying any changes from the approved plan,
- 2.10.2. the measured drawdown per dose cycle,
- 2.10.3. timer functions,
- 2.10.4. residual pressure and/or squirt height at the end of each lateral, as inspected, and
- 2.10.5. pump run time and pump time off.

2.11. User's Manual

The user's manual that is a part of the design submittal must contain, at a minimum, the following:

- 2.11.1. diagrams of the system components,
- 2.11.2. explanation of general system function, operational expectations, owner responsibility, etc.,
- 2.11.3. specifications of all electrical and mechanical components installed (occasionally components other than those specified on the plans are used),

- 2.11.4. names and telephone numbers of the system designer, NETCHD, component manufacturers, supplier/installer, and/or the management entity to be contacted in the event of a failure,
- 2.11.5. information on the periodic maintenance requirements of the various components of the sewage system, and
- 2.11.6. information on "trouble-shooting" common operational problems that might occur. This information should be as detailed and complete as needed to assist the system owner to make accurate decisions about when and how to attempt corrections of operational problems, and when to call for professional assistance.

3. Operation and Maintenance

The systems must be monitored and maintained at a frequency commensurate with the site, soil, system complexity and use patterns. As a minimum, it is strongly recommended that the items in 3.1 - 3.5 be inspected at six months and then yearly, after the system is put into use. Refer to the system construction record for initial readings and settings. The owners of pressure distribution systems should be notified that their systems should be inspected and / or serviced on a yearly basis.

3.1. Evaluate Drainfield

- 3.1.1. for indications of surfacing effluent.
- 3.1.2. for appropriate vegetation, landscaping impacts, ponds, etc.
- 3.1.3. for absence of heavy traffic.
- 3.1.4. for inappropriate building.
- 3.1.5. for impervious materials or surfaces.
- 3.1.6. for abnormal settling or erosion.

3.2. Evaluate Laterals

- 3.2.1. for residual pressure at the distal ends. Confirm that it is the same as those recorded on the construction record. If not the same, laterals and orifices need to be cleaned.
- 3.2.2. for equal flows in each lateral.
- 3.2.3. for need for cleaning. Clean laterals and orifices as necessary.

3.3. Measure Pump Run Time per Cycle and Drawdown

Compare these values with those recorded in the construction record. If not the same, evaluate the system for improperly set timer control, float switches, clogged laterals, plugged orifices.

3.4. Test Alarms

Test alarms for proper functioning (high and low liquid level).

3.5. Evaluate Septic Tank and Pump Chamber

- 3.5.1. for sludge and scum accumulations; pump when the sludge and scum thickness total 1/3 of the depth of the tank.
- 3.5.2. for clogging, damage, and proper placement of outlet baffle screen. Clean each time it is inspected or as needed to avoid clogging.
- 3.5.3. for signs of leaking in tanks and risers. Repair or replace if necessary.
- 3.5.4. for risers and lids being above grade and having lids that are secure.
- 3.5.5. for properly functioning of floats. Movement should not be restricted. Floats should be positioned correctly and provide positive instrumentation signals. Adjust and repair as necessary.

3.6. Findings and Repairs

All findings and repairs are to be recorded, records filed for ready access, and reports sent to NETCHD.

Figures

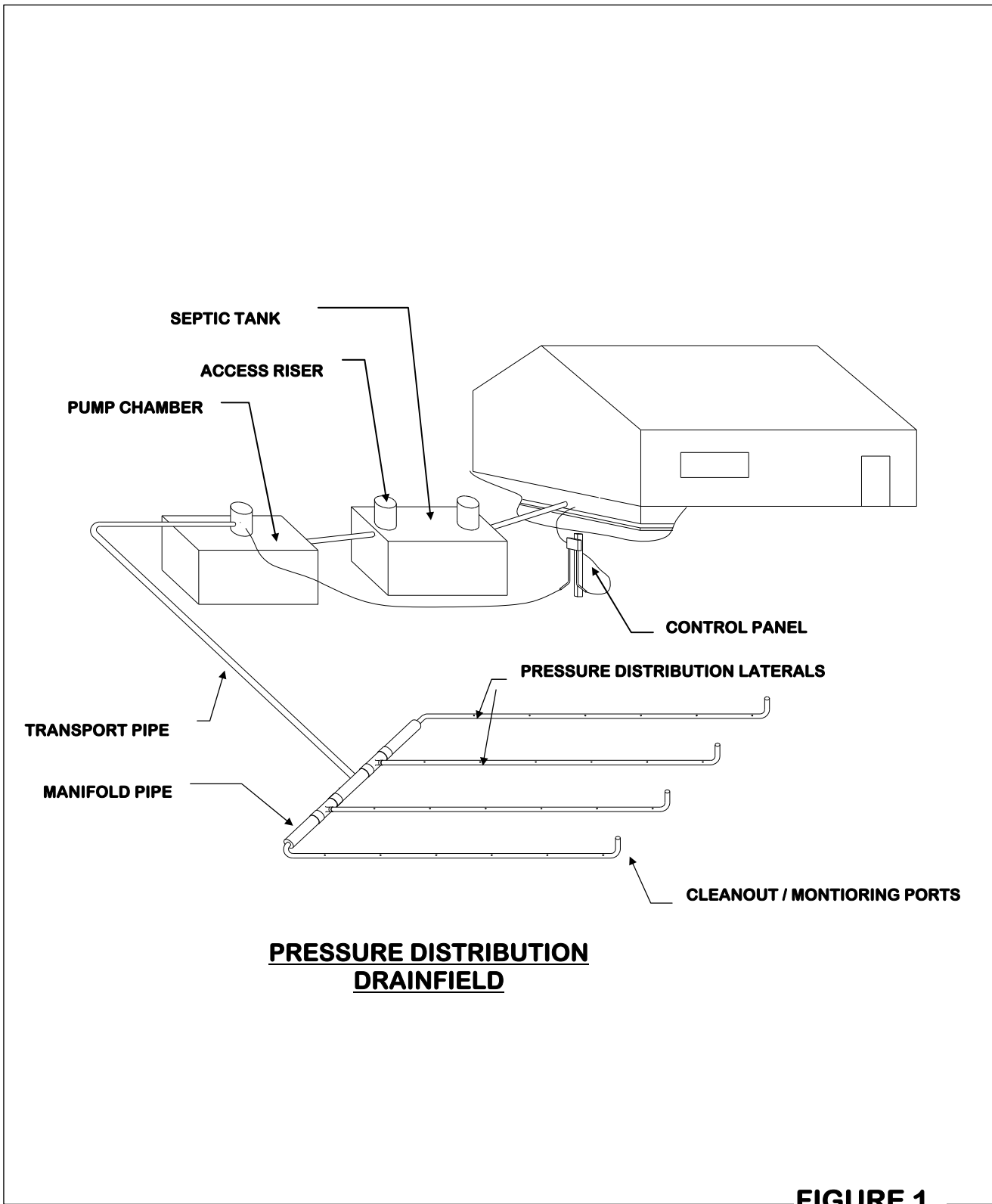
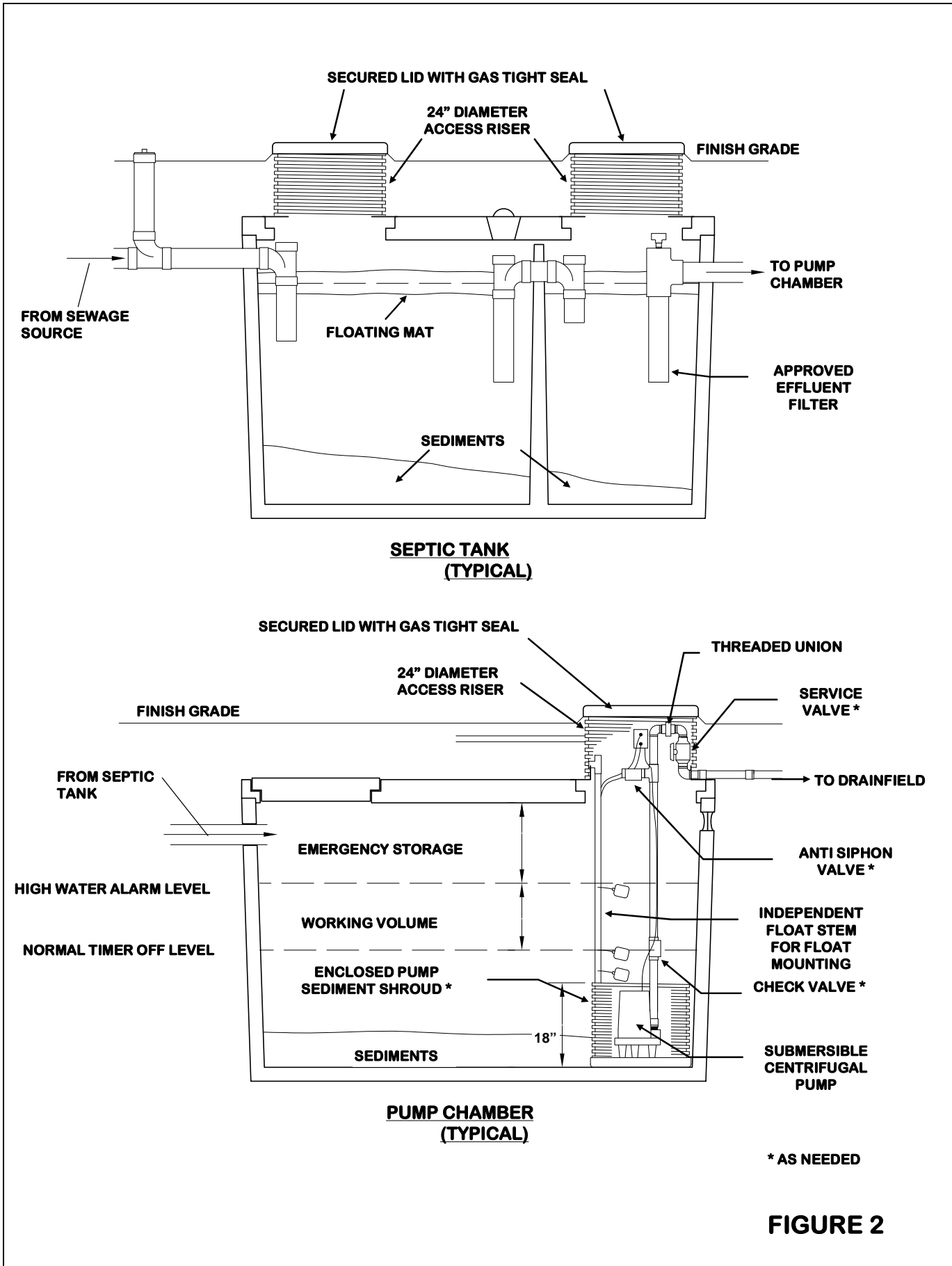
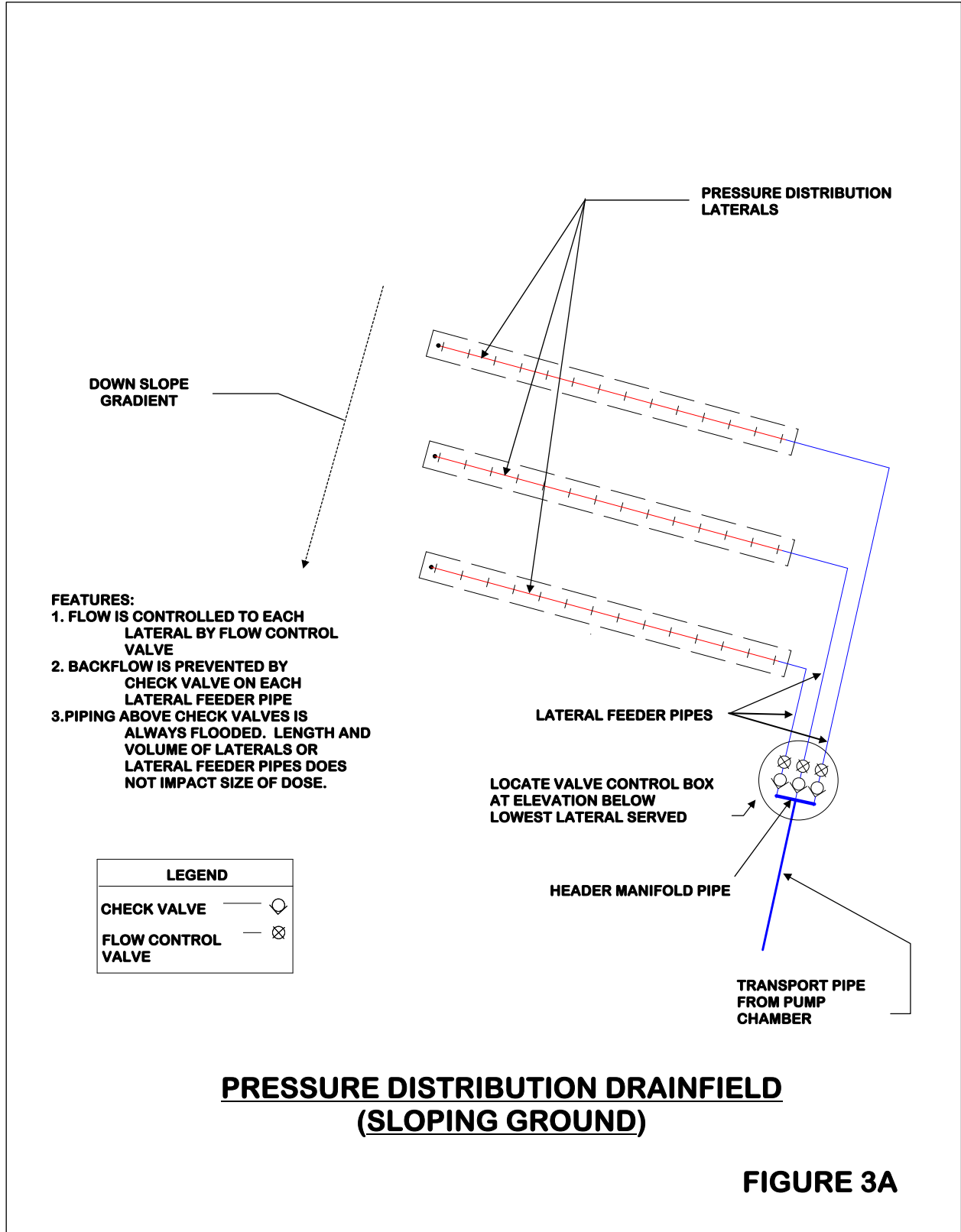
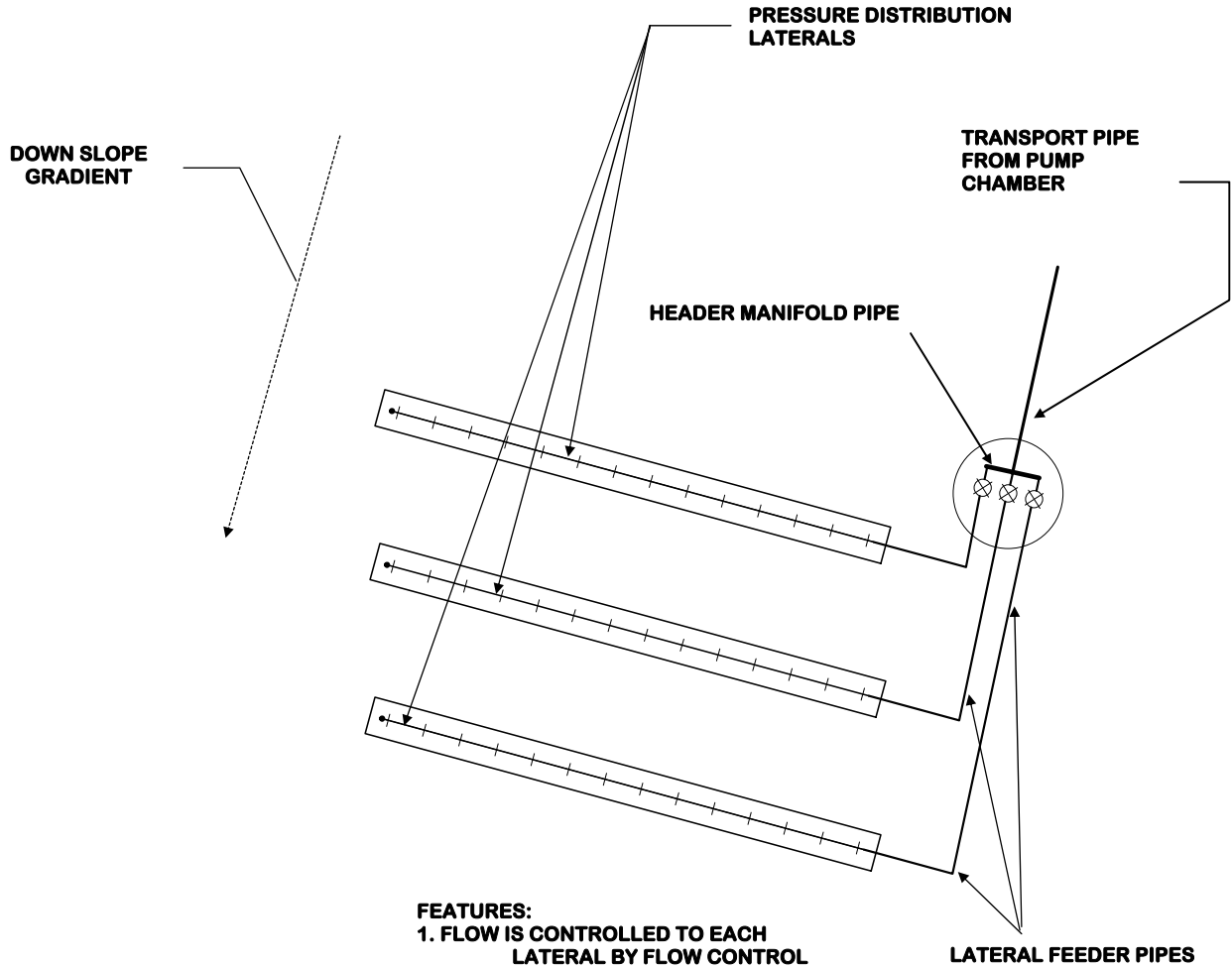

FIGURE 1







- FEATURES:**
1. FLOW IS CONTROLLED TO EACH LATERAL BY FLOW CONTROL VALVE
 2. BACKFLOW IS PREVENTED BY MANIFOLD POSITION ABOVE LATERALS
 3. ACCEPTABLE VARIANCE OF DOSE TO EACH LATERAL MAY BE IMPOSSIBLE DUE TO DIFFERING VOLUMES WITHIN EACH OF THE LATERAL FEEDER PIPES, ALL OF WHICH DRAIN AFTER PUMP CYCLE

LEGEND	
CHECK VALVE	
FLOW CONTROL VALVE	

PRESSURE DISTRIBUTION DRAINFIELD
(SLOPING GROUND)

FIGURE 3B

Manifold Below

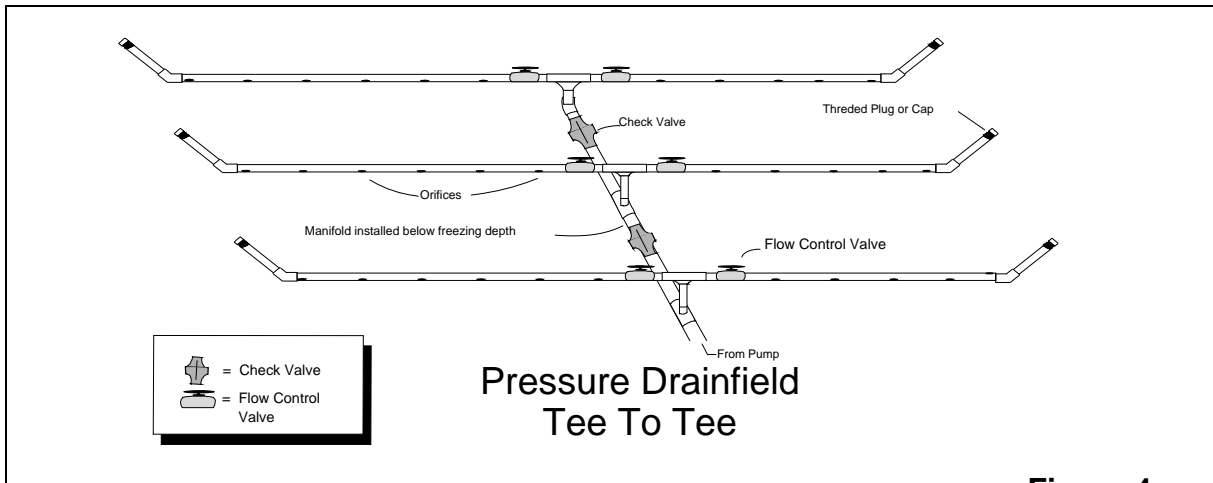

Figure 4

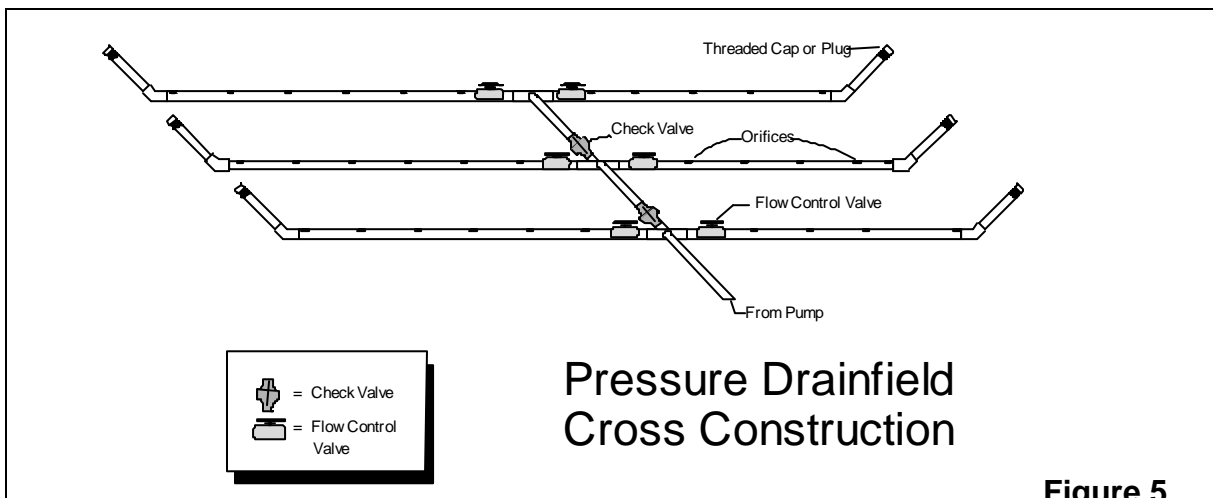
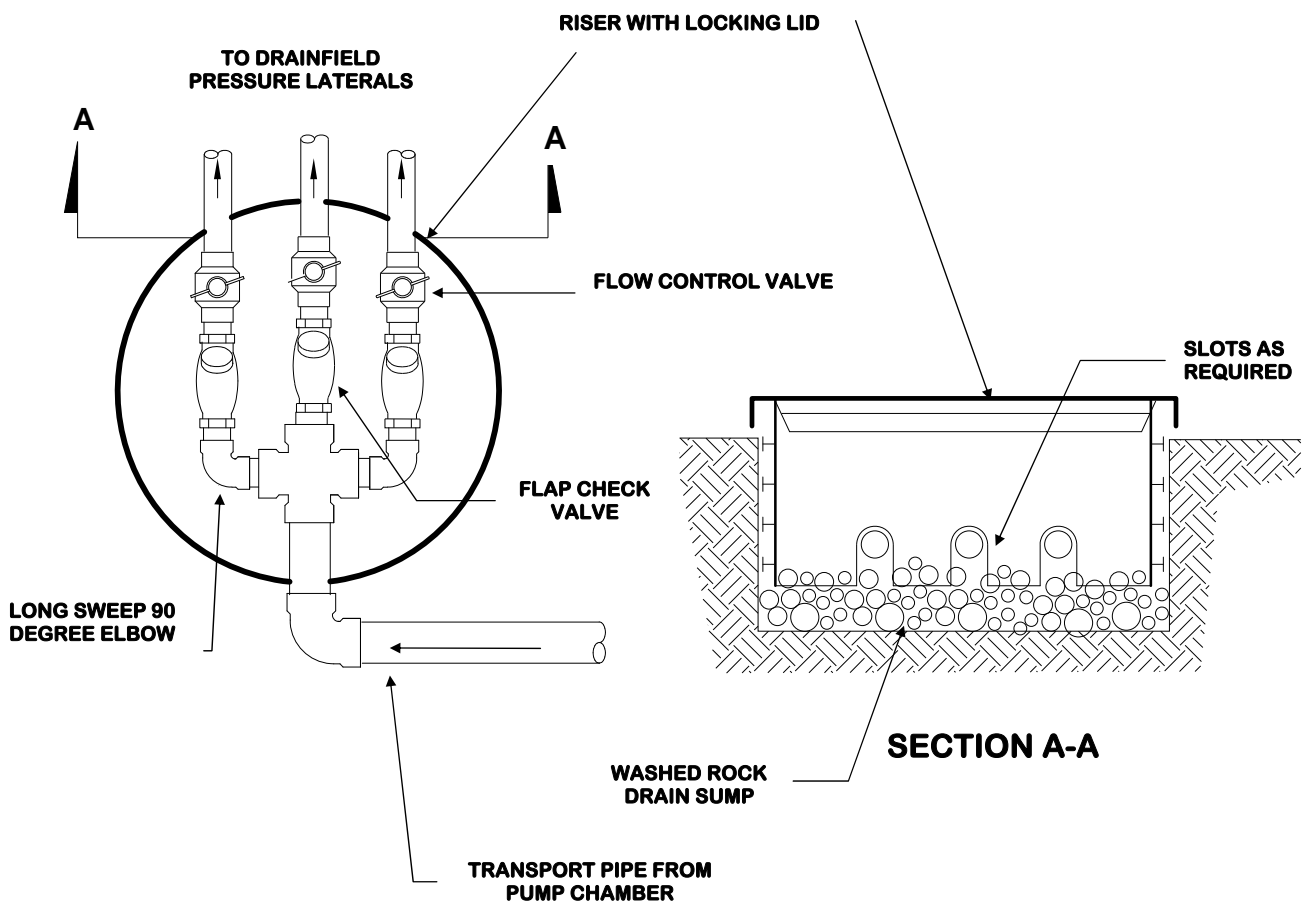

Figure 5



DRAINFIELD CONTROL BOX
(SLOPING GROUND; MANIFOLD BELOW LATERALS)

FIGURE 6A

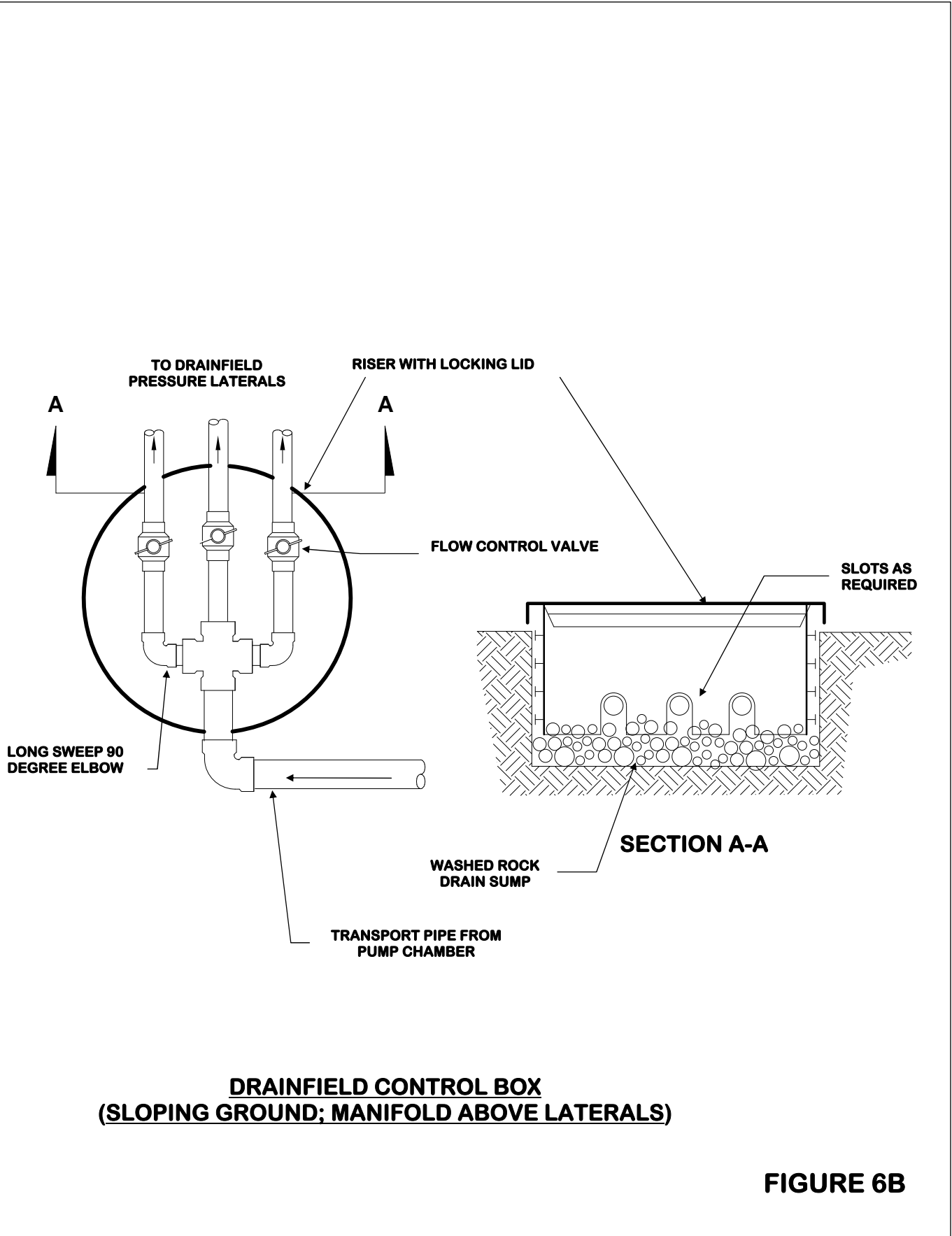
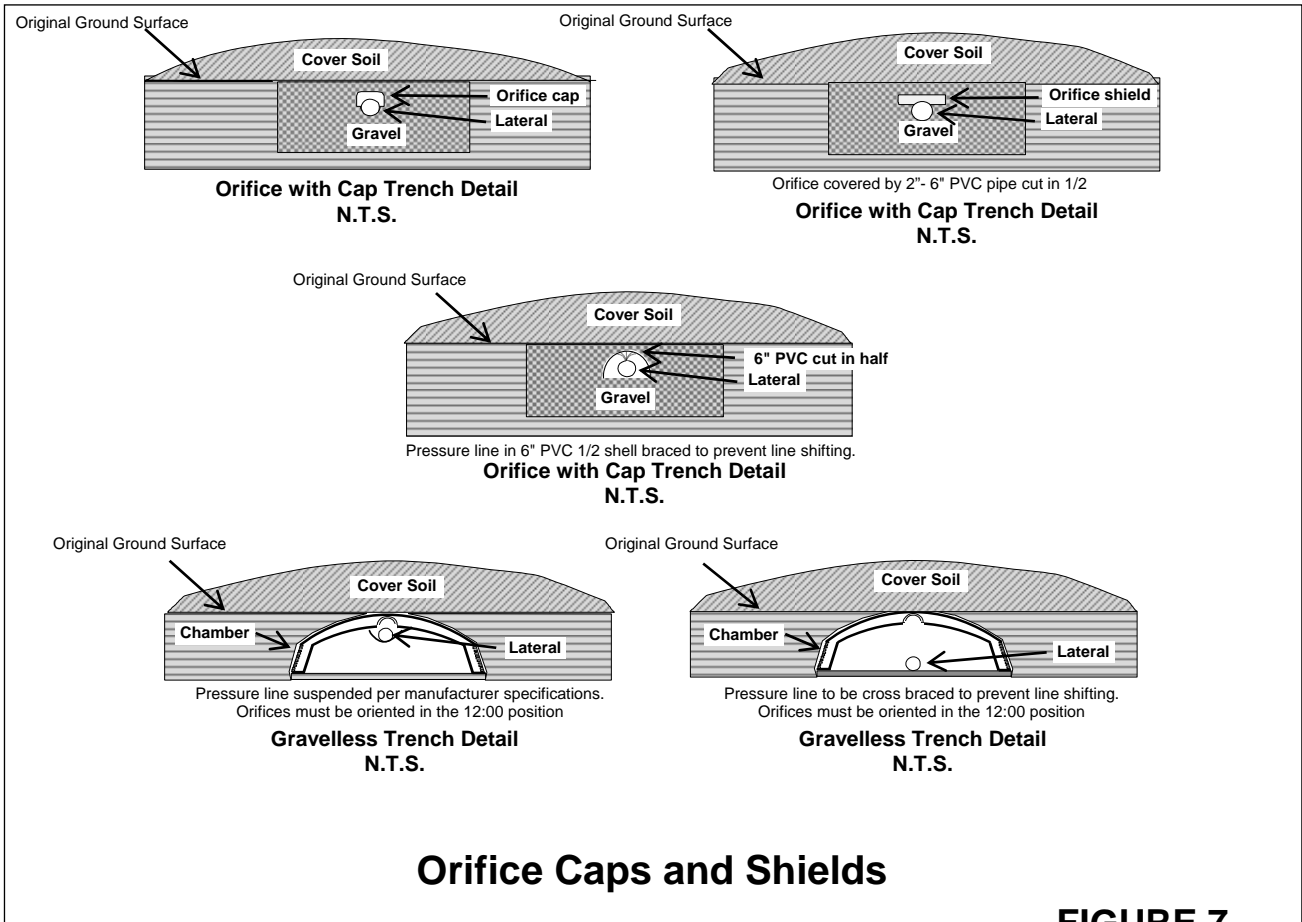

FIGURE 6B



Orifice Caps and Shields

FIGURE 7

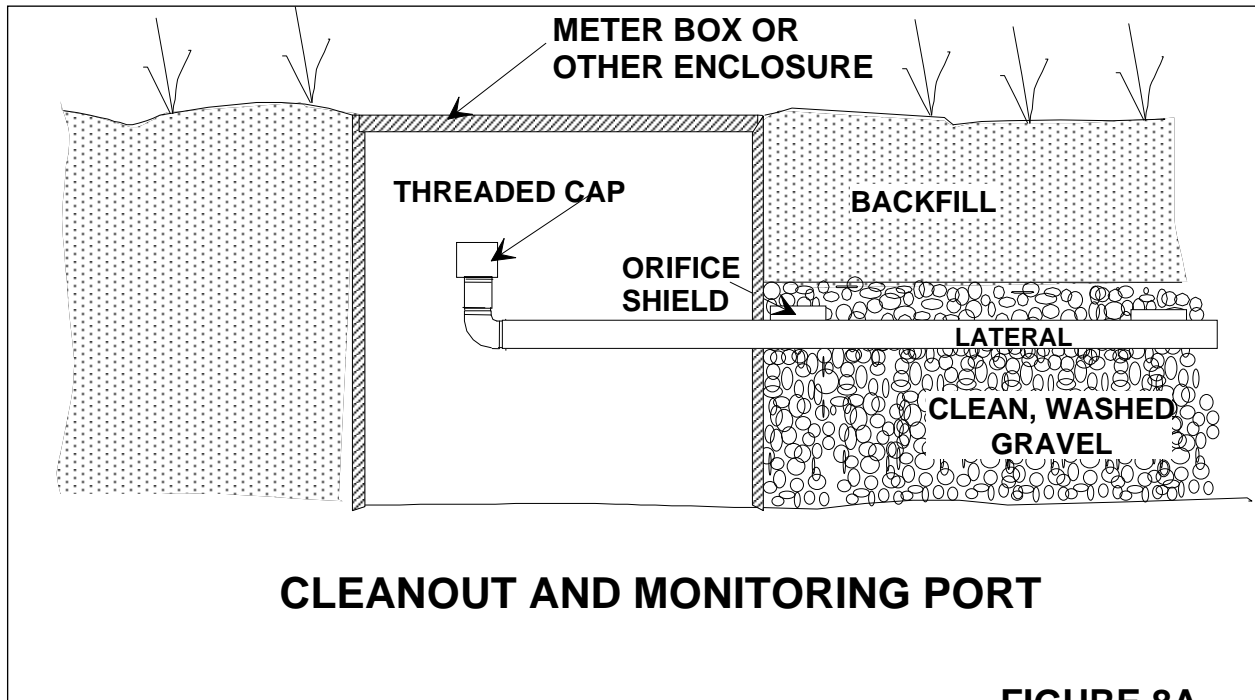

FIGURE 8A

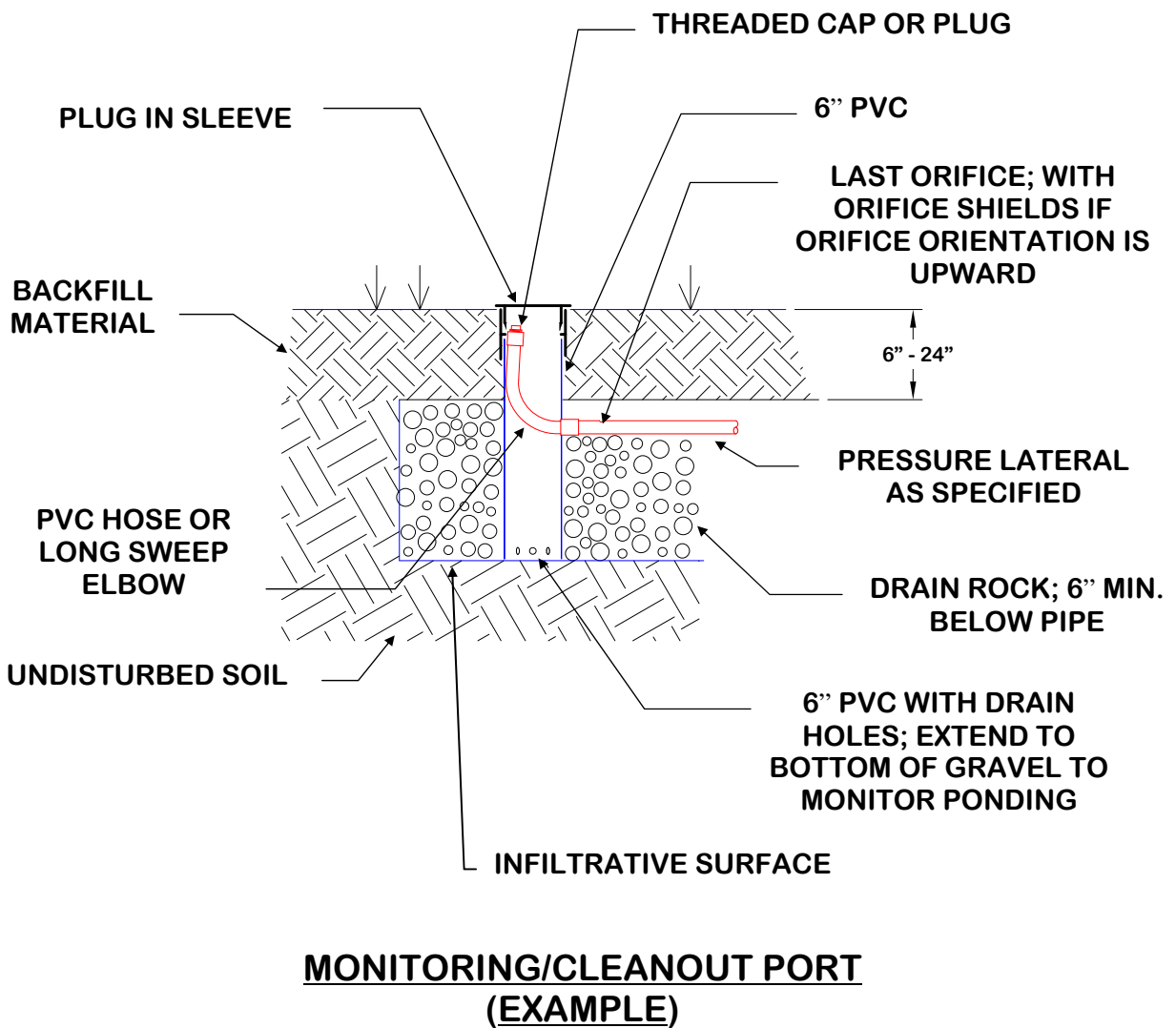
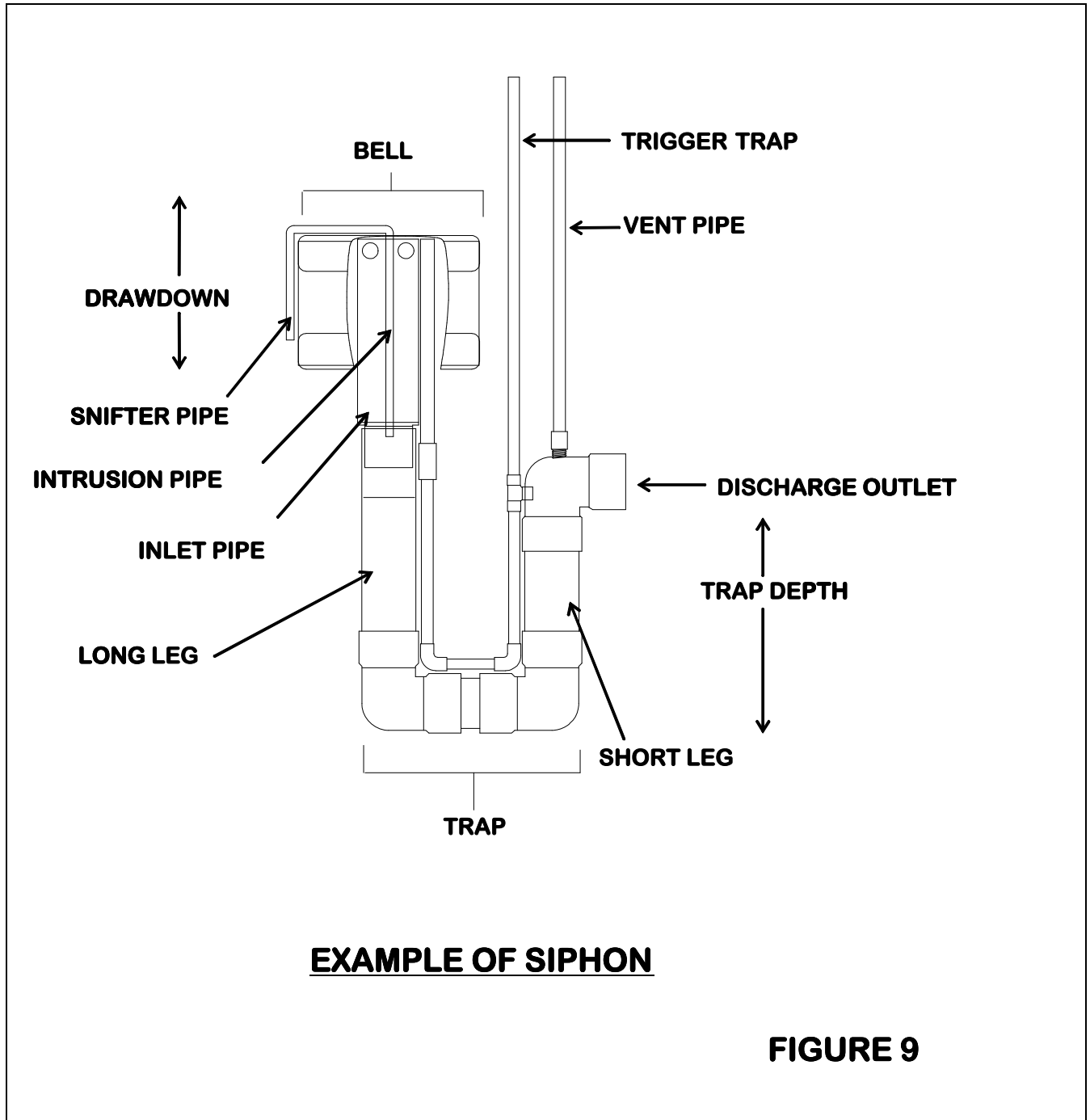
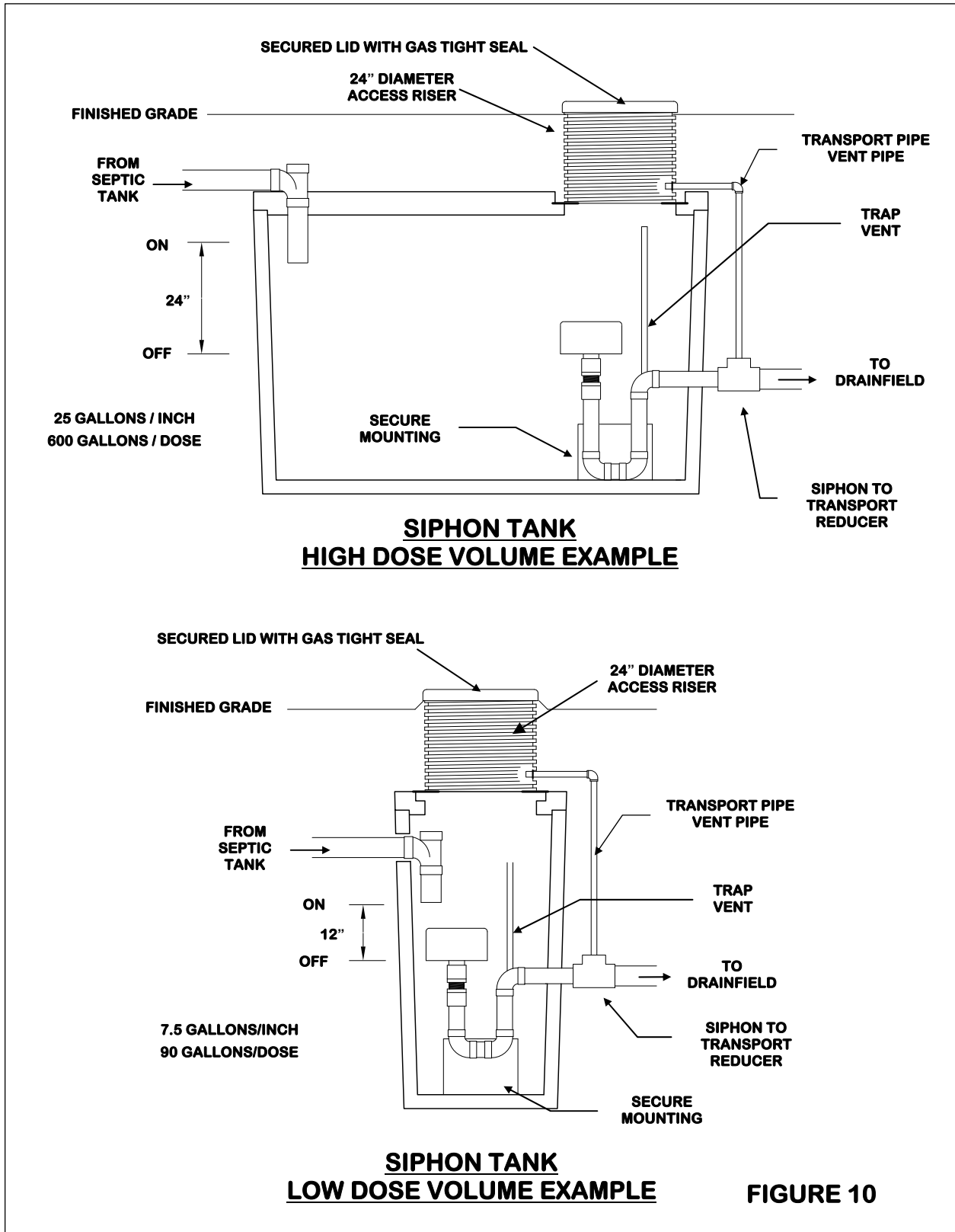

FIGURE 8B





Appendix A – Useful Tables for Pressure Distribution

The design tables in the four sections of this appendix have been developed in order to allow the designer to evaluate alternative lateral configurations.

Appendix A-1, LATERAL DESIGN TABLE, has a table of maximum lateral lengths for various lateral diameters, orifice diameters and orifice spacings, and includes design criteria used to calculate maximum lateral lengths.

Appendix A-2, ORIFICE DISCHARGE RATE DESIGN AID, contains a derivation of an equation used to calculate orifice discharge rates and includes a table of discharge rates for various residual heads and orifice diameters.

Appendix A-3, FRICTION LOSS DESIGN AID, includes a derivation of an equation that can be used to calculate friction losses and a table of constants to simplify the calculation. Also included is a table of friction loss for PVC pipe fittings.

Appendix A-4, MAXIMUM MANIFOLD LENGTHS, lists the assumptions used to calculate the enclosed tables for maximum manifold length, one for 1/8 inch and 5/32 inch orifices (where the minimum residual head at the distal orifice must be 5 feet) and one for orifices of 3/16 inch and up (where the minimum residual head at the distal orifice must be 2 feet).

Throughout Appendix A, it is assumed that laterals and manifolds will be constructed using only PVC pipe materials conforming to ASTM standards D-2241 or D-1785.

A-1: LATERAL DESIGN TABLES

The maximum allowable length for any lateral is determined by allowable differences in discharge rates between the proximal and distal orifices. These tables assume that $Q_p/Q_d \leq 1.1$

Where Q_p = the proximal orifice discharge rate
 Q_d = the distal orifice discharge rate

The maximum allowable difference in discharge rates is 10%. The maximum allowable lateral length is a function of lateral diameter and orifice diameter and is independent of the residual pressure.

Orifice discharge rates are a function of orifice diameter and residual pressure (see Appendix A-2 for a discussion). Table A-1 gives the maximum lateral length for each orifice diameter, lateral diameter, and orifice spacing.

**Table A-1
Lateral Design Table**

			Maximum Lateral Length (ft)		
Orifice	Lateral	Orifice Spacing	Pipe Material		
(inches)	(inches)	(feet)	Schedule 40	Class 200	Class 160
1/8	1	1.5	42	51	
1/8	1	2	50	62	
1/8	1	2.5	57.5	72.5	
1/8	1	3	66	81	
1/8	1	4	80	96	
1/8	1	5	90	110	
1/8	1	6	102	126	
1/8	1.25	1.5	66	76.5	79.5
1/8	1.25	2	80	92	96
1/8	1.25	2.5	92.5	107.5	110
1/8	1.25	3	105	120	123
1/8	1.25	4	124	144	148
1/8	1.25	5	145	165	175
1/8	1.25	6	162	186	192
1/8	1.5	1.5	85.5	96	100.5
1/8	1.5	2	104	116	120
1/8	1.5	2.5	120	135	140
1/8	1.5	3	135	150	156
1/8	1.5	4	164	184	188
1/8	1.5	5	190	210	220
1/8	1.5	6	210	240	246
1/8	2	1.5	132	141	145.5
1/8	2	2	160	170	176
1/8	2	2.5	185	197.5	202.5
1/8	2	3	207	222	228
1/8	2	4	248	268	276
1/8	2	5	290	310	320
1/8	2	6	324	348	360
5/32	1	1.5	31.5	39	39
5/32	1	2	36	46	46
5/32	1	2.5	42.5	52.5	52.5
5/32	1	3	48	60	60

Table A-1
Lateral Design Table (continued)

			Maximum Lateral Length (ft)		
Orifice	Lateral	Orifice Spacing	Pipe Material		
(inches)	(inches)	(feet)	Schedule 40	Class 200	Class 160
5/32	1	4	56	72	72
5/32	1	5	65	80	85
5/32	1	6	72	90	96
5/32	1 1/4	1.5	48	55.5	58.5
5/32	1 1/4	2	58	68	70
5/32	1 1/4	2.5	67.5	77.5	80
5/32	1 1/4	3	75	87	90
5/32	1 1/4	4	92	104	108
5/32	1 1/4	5	105	120	125
5/32	1 1/4	6	120	138	144
5/32	1 1/2	1.5	63	70.5	73.5
5/32	1 1/2	2	76	84	88
5/32	1 1/2	2.5	87.5	97.5	102.5
5/32	1 1/2	3	99	111	114
5/32	1 1/2	4	120	132	136
5/32	1 1/2	5	140	155	160
5/32	1 1/2	6	156	174	180
5/32	2	1.5	96	103.5	106.5
5/32	2	2	116	124	128
5/32	2	2.5	135	142.5	147.5
5/32	2	3	150	162	168
5/32	2	4	184	196	200
5/32	2	5	210	225	235
5/32	2	6	240	252	264
3/16	1	1.5	24	30	
3/16	1	2	28	36	
3/16	1	2.5	32.5	42.5	
3/16	1	3	39	45	
3/16	1	4	44	56	
3/16	1	5	50	65	
3/16	1	6	60	72	
3/16	1.25	1.5	37.5	43.5	45

Table A-1
Lateral Design Table (continued)

			Maximum Lateral Length (ft)		
Orifice	Lateral	Orifice Spacing	Pipe Material		
(inches)	(inches)	(feet)	Schedule 40	Class 200	Class 160
3/16	1.25	2	46	54	56
3/16	1.25	2.5	52.5	62.5	62.5
3/16	1.25	3	60	69	72
3/16	1.25	4	72	84	88
3/16	1.25	5	85	95	100
3/16	1.25	6	96	108	114
3/16	1.5	1.5	49.5	55.5	57
3/16	1.5	2	60	68	70
3/16	1.5	2.5	70	77.5	80
3/16	1.5	3	78	87	90
3/16	1.5	4	92	104	108
3/16	1.5	5	110	120	125
3/16	1.5	6	120	138	144
3/16	2	1.5	76.5	81	84
3/16	2	2	92	98	102
3/16	2	2.5	105	112.5	117.5
3/16	2	3	120	129	132
3/16	2	4	144	152	160
3/16	2	5	165	180	185
3/16	2	6	186	198	210
7/32	1	1.5	19.5	24	
7/32	1	2	24	30	
7/32	1	2.5	27.5	35	
7/32	1	3	30	39	
7/32	1	4	36	44	
7/32	1	5	45	55	
7/32	1	6	48	60	
7/32	1.25	1.5	31.5	36	37.5
7/32	1.25	2	38	44	46
7/32	1.25	2.5	42.5	50	52.5
7/32	1.25	3	48	57	60
7/32	1.25	4	60	68	72
7/32	1.25	5	70	80	80

Table A-1
Lateral Design Table (continued)

			Maximum Lateral Length (ft)		
Orifice	Lateral	Orifice Spacing	Pipe Material		
(inches)	(inches)	(feet)	Schedule 40	Class 200	Class 160
7/32	1.25	6	78	90	90
7/32	1.5	1.5	40.5	45	46.5
7/32	1.5	2	50	54	56
7/32	1.5	2.5	57.5	62.5	65
7/32	1.5	3	63	72	75
7/32	1.5	4	76	88	88
7/32	1.5	5	90	100	105
7/32	1.5	6	102	114	114
7/32	2	1.5	63	66	69
7/32	2	2	76	80	84
7/32	2	2.5	87.5	92.5	95
7/32	2	3	99	105	108
7/32	2	4	116	124	132
7/32	2	5	135	145	150
7/32	2	6	156	162	168
1/4	1	1.5	16.5	21	
1/4	1	2	20	24	
1/4	1	2.5	22.5	27.5	
1/4	1	3	27	33	
1/4	1	4	32	40	
1/4	1	5	35	45	
1/4	1	6	42	48	
1/4	1.25	1.5	27	30	31.5
1/4	1.25	2	32	36	38
1/4	1.25	2.5	37.5	42.5	45
1/4	1.25	3	42	48	48
1/4	1.25	4	48	56	60
1/4	1.25	5	55	65	70
1/4	1.25	6	66	72	78
1/4	1.5	1.5	34.5	39	39
1/4	1.5	2	42	46	48
1/4	1.5	2.5	47.5	52.5	55

Table A-1
Lateral Design Table (continued)

			Maximum Lateral Length (ft)		
Orifice	Lateral	Orifice Spacing	Pipe Material		
(inches)	(inches)	(feet)	Schedule 40	Class 200	Class 160
1/4	1.5	3	54	60	63
1/4	1.5	4	64	72	76
1/4	1.5	5	75	85	85
1/4	1.5	6	84	96	96
1/4	2	1.5	52.5	55.5	58.5
1/4	2	2	64	68	70
1/4	2	2.5	72.5	77.5	80
1/4	2	3	81	87	90
1/4	2	4	100	104	108
1/4	2	5	115	120	125
1/4	2	6	126	138	144

A-2: ORIFICE DISCHARGE RATE DESIGN AID

Orifice discharge rates can be calculated using Toricelli's equation:

$$Q = C_d A_o \sqrt{2gh}$$

Where: Q = the discharge rate in ft³/sec

C_d = the discharge coefficient (unitless)

A_o = the cross sectional area of the orifice in ft²

g = the acceleration due to gravity (32.2 ft/sec²)

h = the residual pressure head at the orifice in ft

The formula shown above can be simplified for design purposes by incorporating the discharge coefficient and using conversion factors so that the discharge is given in gallons per minute and the orifice diameter is given in inches. The discharge coefficient depends on the characteristics of the orifice and is usually determined empirically. This value can range from 0.6 to 0.8 but a value of 0.6 was assumed for the purpose of this design aid. The formula therefore simplifies to:

$$Q = 11.79 d^2 \sqrt{h}$$

Where: Q = the orifice discharge rate in gpm

d = the orifice diameter in inches

h = the residual pressure head at the orifice in feet

On the next page Table A-2 gives orifice discharge rates (in gpm) generated using the above formula for various residual pressures (head) and orifice diameters.

Table A-2

Orifice Discharge Rates (gpm)					
Head (ft)	Orifice Diameter (in)				
	1/8	5/32	3/16	7/32	1/4
2			0.59	0.80	1.04
3			0.72	0.98	1.28
4			0.83	1.13	1.47
5	0.41	0.64	0.93	1.26	1.65
6	0.45	0.71	1.02	1.38	1.80
7	0.49	0.76	1.10	1.49	1.95
8	0.52	0.81	1.17	1.60	2.08
9	0.55	0.86	1.24	1.69	2.21
10	0.58	0.91	1.31	1.78	2.33

For residuals greater than 10 feet or for orifice diameters greater than 1/4 inch, the equation must be used. This is also true if the residual pressure is not a whole number. For large systems use the equation and verify with Table A-2.

Note: Table A-2 was generated assuming that the minimum residual head at the distal orifice is 5 feet when orifices are 1/8 and 5/32 inch in diameter, and 2 feet for larger orifice diameters.

A-3: FRICTION LOSS DESIGN AID

Friction losses in pipes can be calculated using the Hazen-Williams formula:

$$\text{Original form: } V = 1.318 * C * R^{0.63} * S^{0.54}$$

Where: V = velocity (ft/sec)

C = Hazen-Williams flow coefficient (unitless)

R = hydraulic radius (ft²/ft)¹

S = slope of energy grade line (ft/1000 ft)

This equation can be modified through algebraic substitutions and using unit conversions to yield a formula that directly calculates friction loss²:

$$f = \frac{10.46LQ^{1.85}}{C^{1.85}D^{4.87}}$$

Where: f = friction loss (ft)

D = actual inside pipe diameter (in)

L = length of pipe (ft)

Q = flow (gpm)

C = Hazen-Williams flow coefficient (unitless)

The Hazen-Williams flow coefficient (C) depends on the roughness of the piping material. Flow coefficients for PVC pipe have been established by various researchers in a range of values from 155 to 165 for both new and used PVC pipe. A coefficient of C = 150 generally is considered to yield conservative results in the design of PVC piping systems.³

The equation shown above can be further simplified by assuming that only PVC pipe conforming to ASTM standard D-2241 (or D-1785 for Schedule 40 and Schedule 80 pipe) is used. With this assumption, the inside diameters ("D") for the various nominal pipe sizes can be determined and combined with all other constants to yield the following equation:

¹ hydraulic radius = cross sectional area of the conduit divided by the inner perimeter of the conduit.

² Analysis of Pipe Flow Networks, Jeppson, Ann Arbor Science Publications, 1983 (p. 41).

³ Handbook of PVC Pipe Design and Construction, 2nd Edition, Uni-Bell Plastic Pipe Association, 1982.

$$f = L (Q/K)^{1.85}$$

Where:

f = friction loss through pipe (ft)

L = length of pipe (ft)

Q = flow (gpm)

K = Constant from Table C-3-1

(K can be determined for any PVC pipe conforming to the above ASTM standards using the equation $K = 42.17 * D^{2.63}$)

Table A-3-1

Table for Constant “K”			
Nominal Pipe Diameter	Schedule 40	Class 200	Class 160
1	47.8	66.5	
1.25	98.3	122.9	129.4
1.5	147.5	175.5	184.8
2	284.5	315.2	332.5
2.5	454.1	520.7	551.1
3	803.9	873.3	920.5
4	1642.9	1692.7	1783.9
6	4826.6	4677.4	4932

Friction loss for some PVC pipe fittings, given in terms of equivalent length of pipe, are provided in Table A-3-2.

TABLE A-3-2
Friction Loss for PVC Fittings¹

Equivalent Length of Pipe (feet) PVC Pipe Fittings				
Pipe Size (in)	90° Elbow	45° Elbow	Through Tee Run	Through Tee Branch
.5	1.5	0.8	1.0	4.0
.75	2.0	1.0	1.4	5.0
1	2.25	1.4	1.7	6.0
1.25	4.0	1.8	2.3	7.0
1.5	4.0	2.0	2.7	8.0
2	6.0	2.5	4.3	12.0
2.5	8.0	3.0	5.1	15.0
3	8.0	4.0	6.3	16.0
4	12.0	5.0	8.3	22.0
6	18.0	8.0	12.5	32.0
8	22.0	10.0	16.5	38.0

¹ From SPEC-DATA, Sheet 15, Plastic Pipe and Fitting Association, November 1994

A-4: MAXIMUM MANIFOLD LENGTHS

Tables A-4-1 and A-4-2 can be used to determine maximum manifold lengths for various manifold diameters, lateral discharge rates and lateral spacings. The method used to determine the table values is described below.

Pressurized distribution systems are designed to assure even distribution of effluent throughout the drainfield area. Even distribution maximizes the treatment capabilities and useful life of the absorption area. Completely uniform distribution is difficult or impossible to obtain because of friction losses that occur in all piping networks so we settle for a standard or acceptable variance in orifice discharges throughout the network. The maximum lateral lengths in Table A-1 were developed to assure there will be no more than a 10% variance (drop) in the discharge rates between the proximal and distal orifices in any given lateral. The maximum manifold lengths in the tables below were developed to assure there will be no more than a 15% variance in discharge rates between any two orifices in a given distribution system.

Two assumptions used to develop these tables are: (1) the maximum variance in orifice discharge rates within a network occurs between the proximal orifice in the first lateral connected to a manifold and the distal orifice on the last lateral connected to the manifold and (2) the friction loss that occurs between the proximal orifice of a lateral and the point where the lateral connects to the manifold is negligible.

Using the assumptions mentioned above a computer program was developed to calculate maximum manifold lengths for various manifold diameters, lateral discharge rates and lateral spacings. The program assumes that the discharge rate at the distal orifice of the last lateral in a distribution system is as listed in Table A-2 for a given orifice size at the required minimum residual head. That value is multiplied by 1.1 and 1.15 to determine the maximum allowable discharge rates at the proximal orifices of the last and first laterals in the network, respectively. The residual head (h) that corresponds to those discharges was calculated by manipulating the orifice discharge equation in Appendix A-2 and solving for “ h ”.

Using the simplified equation in Appendix A-3, the friction loss that occurs across the manifold was calculated for various materials and pipe diameters (“ K ”), lateral discharge rates (“ Q ”) and lateral spacings (“ L ”). The program adds the friction loss calculated for successive pipe segments to the residual pressure, which corresponds to the proximal orifice discharge at the last lateral. The combined value is compared to the residual pressure at the proximal orifice of the first lateral until it is equal to or greater than this value.

Maximum manifold lengths were calculated as described above for various pipe materials and orifice diameters. Slightly greater manifold lengths were obtained when 1/8 and 5/32 inch orifices were assumed using 5 feet residual pressure at the distal orifice (see Table A-4-2). These tables were generated using Schedule 40 as the pipe material, which yields the most conservative results (shorter manifold lengths).

Table A-4-1
(for orifice diameters of 3/16 in. and up with minimum 2 feet of residual head)

		Maximum Manifold Length (ft)																																			
Lateral Discharge Rate (gpm/lateral)		Manifold Diameter (inches)																																			
		1 1/4						1 1/2						2						3						4						6					
Central Manifold	End Manifold	Lateral Spacing (ft)																																			
		2	3	4	6	8	10	2	3	4	6	8	10	2	3	4	6	8	10	2	3	4	6	8	10	2	3	4	6	8	10	2	3	4	6	8	10
5	10	4	6	4	6	8	10	6	6	8	12	8	10	10	12	16	18	24	20	22	27	32	42	48	60	34	45	52	72	80	90	72	93	112	144	176	200
10	20	2	3	4				2	3	4	6	8		6	6	8	12	8	10	12	15	20	24	32	30	22	27	32	42	48	60	46	57	72	90	112	120
15	30	2						2	3	4				4	6	4	6	8	10	10	12	12	18	24	20	16	21	24	30	40	40	34	45	52	66	80	90
20	40							2						2	3	4	6	8		8	9	12	12	16	20	12	18	20	24	32	30	28	36	44	54	64	80
25	50													2	3	4				6	9	8	12	16	10	10	15	16	18	24	30	24	30	36	48	56	60
30	60													2	3	4				6	6	8	6	8	10	10	12	16	18	24	20	22	27	32	42	48	60
35	70													2	3					4	6	8	6	8	10	8	12	12	18	16	20	18	24	28	36	40	50
40	80													2						4	6	4	6	8	10	8	9	12	12	16	20	18	21	28	36	40	40
45	90																			4	3	4	6	8	10	6	9	8	12	16	20	16	21	24	30	32	40
50	100																			4	3	4	6	8	10	6	9	8	12	16	10	14	18	24	30	32	40
55	110																			2	3	4	6	8		6	6	8	12	8	10	14	18	20	24	32	30
60	120																			2	3	4	6			6	6	8	12	8	10	12	15	20	24	32	30
65	130																			2	3	4	6			6	6	8	6	8	10	12	15	20	24	24	30
70	140																			2	3	4				4	6	8	6	8	10	12	15	16	24	24	30
75	150																			2	3	4				4	6	8	6	8	10	10	15	16	18	24	30
80	160																			2	3	4				4	6	4	6	8	10	10	12	16	18	24	30
85	170																			2	3					4	6	4	6	8	10	10	12	16	18	24	20
90	180																			2	3					4	3	4	6	8	10	10	12	12	18	24	20
95	190																			2	3					4	3	4	6	8	10	8	12	12	18	16	20
100	200																			2						4	3	4	6	8	10	8	12	12	18	16	20

Instructions: This Table can be used to determine maximum length of a given diameter manifold *or* to determine required minimum diameter for a given manifold length.

Known values must include:

- 1) Manifold - lateral configuration (end or central)
- 2) Lateral discharge rate "Q" in gallons per minute
- 3) Lateral spacing in feet

Example A: Central manifold configuration, lateral discharge "Q" = 40 gpm, lateral spacing = 6 ft., manifold diameter = 4 inch; Maximum length = 12 ft.

Example B: End manifold configuration, lateral discharge "Q" = 30 gpm, lateral spacing = 6 ft., manifold length = 18 ft.; Minimum diameter = 3 inch

TABLE A-4-2
(for orifice diameters of 1/8 in. and 5/32 in. with minimum 5 feet of residual head)

Maximum Manifold Length (ft)																																					
Lateral Discharge Rate (gpm/lateral)		Manifold Diameter (inches)																																			
		1 1/4						1 1/2						2						3						4						6					
Central Manifold	End Manifold	Lateral Spacing (ft)																																			
		2	3	4	6	8	10	2	3	4	6	8	10	2	3	4	6	8	10	2	3	4	6	8	10	2	3	4	6	8	10						
5	10	6	9	8	12	16	10	8	12	12	18	16	20	14	18	20	30	32	40	30	39	48	60	72	80	48	63	76	96	120	130	100	129	156	204	240	280
10	20	4	3	4	6	8	10	4	6	8	6	8	10	8	12	12	18	16	20	18	24	28	36	40	50	30	39	48	60	72	80	64	81	100	126	152	180
15	30	2	3	4				4	3	4	6	8	10	6	6	8	12	8	10	14	18	20	24	32	30	22	30	36	42	56	60	48	63	76	96	112	130
20	40	2						2	3	4	6			4	6	8	6	8	10	12	15	16	18	24	30	18	24	28	36	40	50	40	51	60	78	96	110
25	50							2	3	4				4	6	4	6	8	10	10	12	12	18	16	20	16	21	24	30	40	40	34	45	52	66	80	90
30	60							2						4	3	4	6	8	10	8	9	12	12	16	20	14	18	20	24	32	40	30	39	48	60	72	80
35	70							2						2	3	4	6			8	9	12	12	16	20	12	15	20	24	24	30	26	36	40	54	64	70
40	80													2	3	4				6	9	8	12	16	10	12	15	16	18	24	30	24	30	36	48	56	70
45	90													2	3	4				6	6	8	12	8	10	10	12	16	18	24	20	22	30	36	42	56	60
50	100													2	3					6	6	8	6	8	10	10	12	12	18	24	20	20	27	32	42	48	60
55	110													2	3					4	6	8	6	8	10	8	12	12	18	16	20	20	24	28	36	48	50
60	120													2						4	6	8	6	8	10	8	9	12	12	16	20	18	24	28	36	40	50
65	130													2						4	6	4	6	8	10	8	9	12	12	16	20	18	21	28	36	40	50
70	140													2						4	6	4	6	8	10	8	9	12	12	16	20	16	21	24	30	40	40
75	150																			4	3	4	6	8	10	6	9	8	12	16	20	16	21	24	30	32	40
80	160																			4	3	4	6	8	10	6	9	8	12	16	10	14	18	24	30	32	40
85	170																			4	3	4	6	8		6	9	8	12	16	10	14	18	20	30	32	40
90	180																			2	3	4	6	8		6	6	8	12	8	10	14	18	20	24	32	30
95	190																			2	3	4	6	8		6	6	8	12	8	10	14	18	20	24	32	30
100	200																			2	3	4	6			6	6	8	12	8	10	12	15	20	24	32	30

Instructions: This Table can be used to determine maximum length of a given diameter manifold *or* to determine required minimum diameter for a given manifold length.

Known values must include:

- 1) Manifold - lateral configuration (end or central)
- 2) Lateral discharge rate “Q” in gallons per minute
- 3) Lateral spacing in feet

Example A: Central manifold configuration, lateral discharge “Q” = 40 gpm, lateral spacing = 6 ft., manifold diameter = 4 inch; Maximum length = 18 ft.

Example B: End manifold configuration, lateral discharge “Q” = 30 gpm, lateral spacing = 6 ft., manifold length = 24 ft.; Minimum diameter = 3 inch

Appendix B – Volume of Pipe
(gallons per foot)

Nominal Diameter (in)	Type of Pipe		
	PR 160	PR 200	Schedule 40
0.75		0.035	0.028
1	0.058	0.058	0.045
1.25	0.098	0.092	0.078
1.5	0.126	0.121	0.106
2	0.196	0.188	0.174
2.5	0.288	0.276	0.249
3	0.428	0.409	0.384
4	0.704	0.677	0.661
5	1.076	1.034	1.039
6	1.526	1.465	1.501
8	2.586	2.485	
10	4.018	3.861	
12	5.652	5.432	

Appendix C - Advantages / Disadvantages of Dosing Systems

Demand Dosing, Timed Dosing, Reduced Dose Volumes, Orifices in 12:00 o'clock Position, Orifices in 6:00 o'clock Position, Network Remaining Full or Partially Full between doses

1. Demand Dosing

- a. Least complex of control systems and therefore least costly to install and easiest to understand.
- b. Not sensitive to heavy use days and therefore will not activate the alarm circuit with weekend guests, large laundry days or parties.
- c. Does not protect the drainfield, mound or sand filter from hydraulic surges and overload.
- d. Does not meter the effluent to the receiving component throughout a 24 hour period; instead delivers the dose whenever a dose volume accumulates in the pump chamber. Household water use patterns are usually in morning, evening and weekend surges.

2. Timed Dosing

- a. Meters the effluent to the receiving component in discrete, evenly spaced doses.
- b. Allows more frequent, smaller doses to be pumped to the receiving component, thereby promoting unsaturated flow through the soil or filter media.
- c. Protects the receiving component from hydraulic overload.
- d. Sensitive to heavy use days and therefore may often activate the alarm circuit when the volume of wastewater exceeds the design flow. Some causes are: weekend guests, large laundry days, parties, and leaking fixtures.
- e. More costly and complicated installation and maintenance.
- f. Can be used to help detect groundwater leaking into the septic tank or pump chamber.

3. Reduced Dose Volumes

- a. More frequent, smaller doses with intervening resting and aeration periods, are pumped to the receiving component, thereby assuring unsaturated flow through the soil or filter media.
- b. May require smaller orifices, smaller transport and lateral pipes, check valves and orifices in the 12 o'clock position in order to reduce the flow rate and to maintain the system full of effluent between doses. The smaller orifices will increase the frequency of maintenance due to clogging. Likewise, maintaining the pipes full of effluent between doses will promote more rapid biological growth on the inside of the pipes and thereby promote clogging of the orifices.

4. Orifices in the 12 o'clock Position

- a. As mentioned above, orifices in this position will maintain the laterals full or partially full and therefore reduce the amount of effluent needed to pressurize the system. This feature is important when designing a system with reduced dose volumes.
- b. Orifices in the "up" position require the use of orifice shields or chambers, to prevent blocking of some orifices with gravel pieces. Shields also deflect the squirt over a wider surface area and spread the effluent over more of the infiltrative surface. Shields have the greatest importance in systems with medium to coarse sand soils or with imported media providing the treatment.
- c. Maintaining effluent in the lines will promote biological growth, which will accelerate clogging of the orifices and buildup of sludge and slime in the lines. It also makes the laterals subject to freezing in areas where this is a concern.
- d. May be drained by putting a few orifices in the 6:00 o'clock position, or by draining laterals and transport line back to the surge tank. However, these practices will increase the dose volume required.

5. Orifices in the 6 o'clock Position

- a. When some or all of the orifices are in the "down" position, the laterals will drain between dose cycles retarding the biological growth in them and reducing freeze up potential. When the system drains, a good rule of thumb for equal distribution is to design the dose volume to be at least 7 times the volume of the liquid that drains after a dose.
- b. When the orifice at the distal end (farthest from the manifold) is in the down position, sludge in the lines tends to be driven to the distal end of the lateral and out the last orifice. As that orifice clogs, the next in line will clog, and so on.
- c. Although systems with some or all of the orifices in the down position may be less prone to clogging, they also will require a larger dose volume to pressurize the system, due to laterals draining between pump cycles.
- d. Orifices in the down position cannot be directed to gravelless chambers, and therefore will not have as wide a distribution pattern. However there are special orifice shields available for orifices oriented in this position.

6. Network Remaining Full, or Partially Full, Between Doses

(laterals can rarely be maintained at a level grade, therefore some orifices will be lower than others, so some of the effluent will drain out the lowest 12:00 o'clock orifice)

- a. Allows smaller, more frequent doses with intervening resting and aeration periods, to be pumped to the receiving component, thereby promoting unsaturated flow through the soil or filter media.
- b. Maintaining effluent in the lines will promote biological growth, which will accelerate clogging of the orifices and buildup of sludge in the lines. It also makes the laterals subject to freezing in areas where this is a concern.

Appendix D - Advantages / Disadvantages of Siphon Dosed Systems

1. Some advantages of siphons are:
 - a. they do not require electricity;
 - b. there are no moving parts;
 - c. they can be constructed entirely of corrosion resistant material;
 - d. they require very little maintenance;
 - e. they do not require external controls as cycling is automatic;
 - f. duplex installations can be made to alternate automatically;
 - g. they can dose a remote drainfield without a large transport line to the siphon chamber;
 - h. they allow the use of small pumps with low energy consumption, to dose a system with high velocity requirements.

2. Some drawbacks of siphons are:
 - a. they cannot, by themselves, limit the total volume discharged to the drainfield in a day and therefore cannot protect the pressure distribution component from hydraulic overload;
 - b. they can go into a trickling mode and will remain there until manually recharged with air; this condition does not achieve equal distribution and may destroy the receiving component;
 - c. they are slower to enter the fully pressurized phase which can result in somewhat unequal distribution on a sloped site; and
 - d. the available head to pressurize the system is fixed and therefore design and installation errors cannot be overcome by increasing the pressure head.

Appendix E - References

Converse, J.C., 1974. Distribution of Domestic Waste Effluent in Soil Absorption Beds, Transactions of the American Society of Agricultural Engineers, Vol. 17, No2, pp. 299-309.

Converse, J.C., J.L. Anderson, W.A. Ziebell, and ZJ. Bouma, 1975. Pressure Distribution to Improve Soil Absorption systems, Home Sewage Disposal, Proceedings National Home Sewage Disposal Symposium, American Society of Agricultural Engineers, St. Joseph, MI pp. 104-115.

Otis, R.J., J.C. Converse, B.L. Carlisle, and J.E. Witty, 1978. Effluent Distribution, Home Sewage Treatment, Proceedings of the 2nd National Home Sewage Treatment Symposium, American Society of Agricultural Engineers, St. Joseph, MI pp. 61-85.